

INTERNATIONAL ASSOCIATION OF ATHLETICS FEDERATIONS



# RUN! JUMP! THROW!



*The Official IAAF Guide  
to Teaching Athletics*





# RUN! JUMP! THROW!

*The Official IAAF Guide  
to Teaching Athletics*



© The International Association of Athletics Federations 2009

Any section of this book may be photocopied for non-profit teaching purposes within educational institutions or coach education settings provided that the original IAAF source is visibly and prominently quoted.

Apart from these specific permissions, no part of this book may be included in any publication, magazine, newsletter, journal or stored in a retrieval system or transmitted in any form, or by any means, electronic, mechanical, photocopying, recording or otherwise without the prior written permission of the International Association of Athletics Federations.

Source publication *Run! Jump! Throw!*, IAAF 1996

Authors: Harald Müller and Wolfgang Ritzdorf

Editor: Bill Glad

This edition edited and authored by Peter Thompson

Technical Photosequences: Charles Gozzoli

High Resolution Photo Images: Getty Images

Graphic Design and Layout by Britta Sendlhofer,  
Descartes Publishing

Printed by Warners Midlands plc, The Maltings, Manor Lane,  
Bourne, Lincolnshire PE10 9PH, UK

# RUN! JUMP! THROW!



*The Official IAAF Guide to Teaching Athletics*

## CONTENTS

President's Message	1
Foreword	1
Acknowledgements	2

### RUN



Fundamentals of Running	5
Sprints	11
Crouch Start	21
Middle and Long Distance Running	33
Relays	45
Hurdles	61
Steeplechase	73
Race Walking	83

### JUMP



Fundamentals of Jumping	97
Long Jump	103
Triple Jump	115
High Jump	125
Pole Vault	137

### THROW

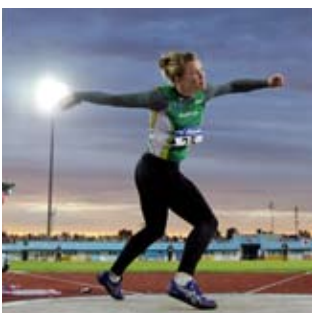

Fundamentals of Throwing	153
Javelin	161
Shot - Linear	177
Shot - Rotational	191
Discus	207
Hammer	223

### RUN, JUMP & THROW

Combined Events	241
-----------------	-----



## PRESIDENT'S MESSAGE

I am very pleased to welcome the publication of the latest edition of 'Run! Jump! Throw!' - the official IAAF guide to teaching athletics. I am convinced that this book, which has already served the sport well, will have a very positive impact in this new, updated and simplified practical format.

It is evident that the work of qualified coaches is vital for the development of athletics in all countries. It is also clear that the coach working in schools, clubs and other local organisations plays a key role in the identification, motivation and development of those athletes who go on to become champions. For this reason, the education of coaches has been an important and ongoing goal of the Development Programme of the IAAF since 1980.

I would like to thank the main authors for their experienced input and conscientious work. I also would like to thank the specialists and consultants from all over the world for their contribution to this important publication and to the whole programme in general.

Finally, I would like to express my gratitude to the Member Services Department as well as the lecturers and the coaches for their contribution to the success of the IAAF Coaches Education and Certification System.

Lamine Diack, IAAF President



## FOREWORD

This book was originally written because time and time again the coach-lecturers who were educating new coaches needed it. But, when they searched for such a book they came up empty-handed.

In addition, many sports students desperately want a simple guide to the techniques of athletics that they can take out and use in schools and on the training track. As coaches gain experience they know that an easy-to-use reference would be invaluable as a quick review of the basics before coaching an event which they had perhaps been away from for a while.

The IAAF Development Programme and the Coaches Education and Certification System (CECS) in 1991 produced the publication entitled *Techniques of Athletics and Teaching Progressions* to fill this need. Coaches felt that this book was a big step in the right direction and it was used by all IAAF Level I Lecturers. The authors of this text, with the support of many experts from around the world, have updated the original publications to produce *Run! Jump! Throw!*, the book you are now holding.

In this most recent version, Charles Gozzoli has 'brought the book to life' by adding photograph sequences to accompany the old line drawings and for the text, Peter Thompson has edited and updated the material, adding the text boxes for 'Coaches should...' and 'Help athletes to...' and the teaching progressions 'Tips'.

The IAAF's aim is to provide what coaches need and what the contributors believe new and experienced coaches around the world want – enough guidance to allow them to get on with their work and learn by doing. *Run! Jump! Throw!* does just that in a clear, user-friendly format. Now, when you search for such a book, it will be there.

Work on the contents of *Run! Jump! Throw!* started from the premise that to teach and refine athletic technique properly coaches need the following four things:

- An understanding of the key points for teaching and learning the event
- A technical model for their athletes to emulate
- The ability to analyse technique themselves
- A programme of activities through which their athletes can learn and develop the desired technique.

*Run! Jump! Throw!* is divided into three main sections, each covering one of the event groups which make up the title. The main sections start with a very brief review of the fundamentals of the event group. These include the most important points of basic theory - the common aims, the key biomechanical principles and an overview of the phase structures - the basic exercises, teaching tips and examples of games which help to introduce the skills demanded by the events in the group. The running events section also features a brief overview of training for middle and long distance running.

The bulk of each section is taken up by visual descriptions of the techniques of the events in the group. These start with an overview of the whole sequence. Then the models are broken down into constituent parts or phases, each of which is presented on the same page as the objectives of the phase and key technical characteristics for the coach to observe and control. Additionally, text boxes provide some of the principal points the coaches should act on, and what they should be helping athletes to achieve. We believe that this format is unique in coaching literature and that coaches of all experience levels will find it easy to apply the information in practice.

Each technical model is followed immediately by a teaching progression of steps by which a beginner, guided by the coach, can learn the event. Again, in addition to visual information, the objective of each step and other key points are given, along with 'Tips' to assist practice.

The authors are aware that the phase breakdown and the teaching progressions of some events might be contentious and the IAAF does not mean to imply that those that are presented are the only ones that are correct. However, the reasonable and orthodox models that have been selected give coaches valuable tools that they can work with immediately, effectively and safely. This, in our opinion, is far better than leaving them to the time consuming and haphazard task of creating their own models, unguided. If and when an experienced coach finds the need to develop a new analysis or teaching steps for an event, we hope that what we have presented here will be seen as a starting point.

Finally, the IAAF gratefully welcome any comments which might help to improve future editions of this book. These should be directed to the Member Services Department at the IAAF Headquarters, 17 rue Princesse Florestine, BP 359, MC98007 Monaco.

## ACKNOWLEDGEMENTS

The completion of this book was made easier by the work and assistance of a great many expert colleagues around the world. In particular, the IAAF would like to acknowledge the valuable leadership and authorship of:

Harald Müller (GER), Wolfgang Ritzdorf (GER), Peter Thompson (GBR), Charles Gozzoli (FRA).

Additionally, acknowledgement is made, in alphabetical order and not in order of contribution, of the following individuals:

Jim Alford (GBR), Oscar Gadea (URU), Bill Glad (USA), Sergio Guarda (CHI), Herbert Hopf (GER), Guenter Lange (GER), Elio Locatelli (ITA), Victor Lopez (PUR), El Hebil Abdel Malek (MAR), Fletcher McEwen (AUS), Brian Mondschein (USA), Ralph Mouchbahani (GER), Rotimi Obajimi (NIG), Tahar Righi (ALG), Joel Severe (MRI), Debbie Strange (NZL), John Velzian (KEN), Jorge Vieira (POR), Björn Wangemann (GER).





# RUN!

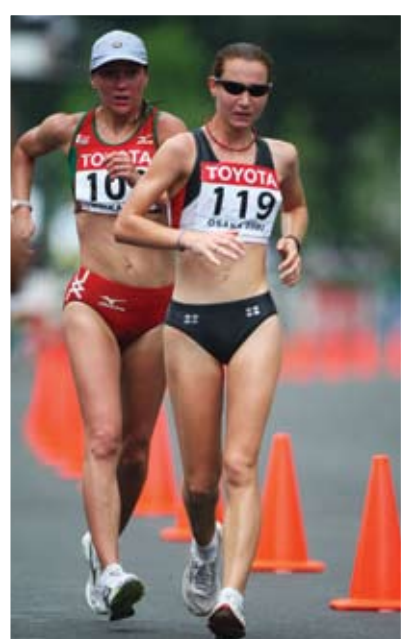

# FUNDAMENTALS OF RUNNING

## 1. INTRODUCTION

---

The running events are sometimes described as non-technical, mainly because running is a natural activity which appears relatively simple when compared to the Pole Vault or the Hammer Throw. However, there is nothing simple about any of the running events. The relative emphasis of speed and endurance dictated by the distance of the race, the crouch start in the sprints, the exchanges in the relays and the presence of barriers in the hurdling and steeplechase races all make technical demands for which athletes must be prepared.

**Note:** For the purpose of this book, Race Walking has been grouped together with the running events. The rules and technique of Race Walking are, of course, very different and a detailed explanation of these differences is given in the Race Walking section.

### **Aims**

The fundamental goal in all running events is to maximise average running speed over the course of the race. To achieve this aim in the sprint events the athlete must focus on reaching and maintaining maximum velocity. In the hurdle events the focus is the same with the added requirement of clearing the hurdles. In the longer events optimising the distribution of effort is of primary importance.

### **Biomechanical Aspects**

An athlete's running velocity is determined by stride length and stride frequency. Optimal stride length is largely determined by the physical characteristics of the athlete and by the force he or she exerts on each stride. This force is influenced by the athlete's strength, power and mobility. Optimal stride frequency is dependent on the athlete's running mechanics, technique and coordination.

Specific endurance and tactics are, of course, important to the overall speed of a race, though from the sprints to the ultra-distances the degree of importance varies.

### **Movement Structure**

Each running stride comprises a **support phase** and a **flight phase**. These can be broken down into **front support** and **drive** phases for the support leg and **front swinging** and **recovery** phases for the free leg.

The two parts of the support phase are of critical importance. In the front support phase there is actually a deceleration of the forward motion of the athlete's body. This must be minimised by (a) an active landing on the ball of the foot and (b) a 'pawing' action of the foot, particularly in sprinting. During this phase energy is stored in the muscles as the leg bends to absorb the shock of landing - a process known as **amortisation**.

The drive phase is the only part of the stride that accelerates the body. The athlete's aim is to direct the greatest amount of force into the ground in the shortest possible time. This force is created by contractions of the leg muscles and the release of the stored energy in the muscles and tendons as the leg extends. To achieve maximum acceleration from each stride it is essential that there is full extension of the ankle, knee and hip joints in combination with an active swing of the free leg and the powerful drive of the arms.

## 2. TEACHING RUNNING TECHNIQUE

Running technique can be taught by introducing the key skills that are related to the elements of all sprint races: reaction, acceleration, maximum speed and speed maintenance. As there is no way to train all elements at once, a variety of exercises and drills focussing on specific aspects are used.

### Points to Emphasise:

- Improving reaction (using various starting signals and starting positions, such as lying, sitting, standing).
- Increasing stride frequency (by working on a high knee action and shortening the pendulum of the free leg).
- Optimising stride length (by working on the extension of the support leg).
- Additional exercises and drills focusing on:
  - a dorsiflexed, 'toe up' ankle at all times
  - the active, 'clawing' action of the feet
  - full body extension
  - powerful but relaxed arm action.
- A wide variety of games involving running and hurdling.

### Points to Remember:

- Use a variety of exercises and drills
- Maximum effort sprints over various distances
- Never work on maximum speed when fatigued
- Most, if not all, of the foot contact will be on the forefoot.

**Note:** The strength and endurance capacities of youngsters are not fully developed. Therefore, exercises and load levels must be carefully considered and set to meet the ability and requirements of the individual.

## 3. SKILL AND CONDITIONING EXERCISES

Basic exercises and drills should be part of almost every training session, particularly for sprinters. They should be carried out after the general warm-up and active mobilisation exercises and should require about 10 minutes. The combined total of repetitions for all the different exercises used in a session should be 15-30.

**Basic Exercise 1: Heel Kick-up Drill**

Loading: 1 rep = 20-30 metres.

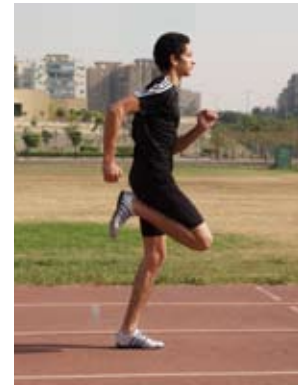
**Basic Exercise 2: Ankling Drill**

Loading: 1 rep = 15 metres.

**Basic Exercise 3: High-knee Drill**

Loading: 1 rep = 20-30 metres.

**Basic Exercise 4: High-knee with Extension**

**Note:** 'Clawing' action of the foot; simultaneous with extension of the knee joint of the free leg.

Loading: 1 rep = 20-30 metres.

**Exercise Group 1: Combinations and variations**

- Basic exercises with one leg then change leg for second repetition.
- High-knee – three running strides – Heel Kick-up – three running strides – High-knee – etc.
- High-knee – Heel Kick-up – three running strides – High-knee –
- Heel kick-up - etc.

Loading: 1 rep = 40-60 metres.

**Exercise Group 2: Combinations and transitions**

- From Ankling to High-knee.
- From High-knee to sprinting.
- From Heel Kick-up to sprinting.
- From High-knee with Extension to sprinting.

Loading: 1 rep = 40-60 metres.

**Exercise Group 3: Arm Action**

- Fix arms by grasping the hips. Accelerate for 20 metres, keeping arms fixed. Release arms then sprint normally.
- Hold hands up. Accelerate for 20 metres. Drop arms then sprint normally.

Loading: 1 rep = 40-60 metres.

**Exercise Group 4: Ins and outs**

- Accelerate for 10 metres – float for 10-15 metres – accelerate for 10 metres – float for 10-15 metres - etc.  
Up to a maximum of 100 metres.

## 4. GAMES

### SPRINT GAME

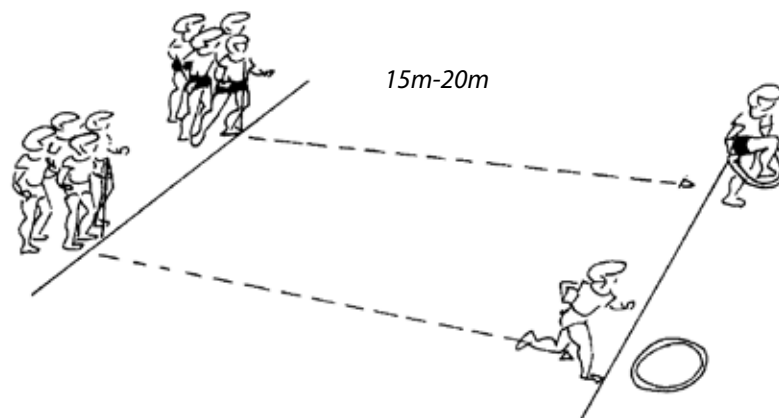

A tyre or hoop is placed at the far end of each team's course. The runners sprint to the tyre and slip through it before starting the next runner with a hand clap.

**Variation:** All runners start together and slip through the tyre before sprinting back to the starting point together.

### RELAY GAME

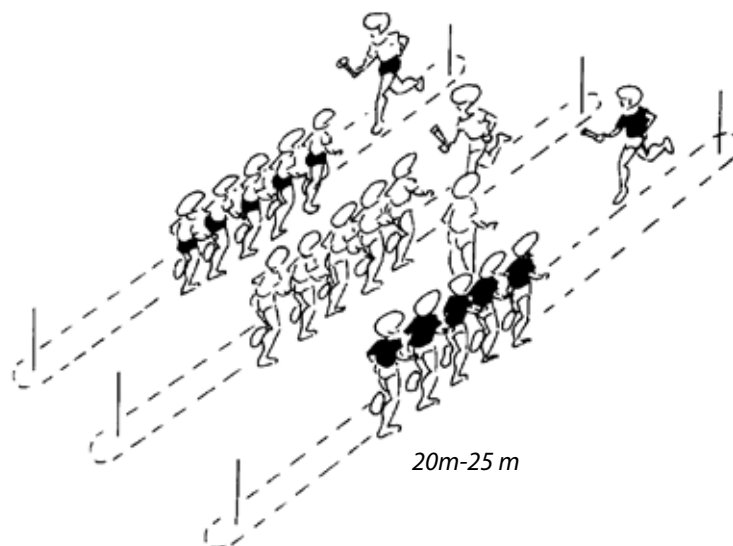

Teams run easily in single file around two turning marks. The first runner of each team carries a baton. On an agreed signal he/she sprints away from the rest of the team and follows the course until reaching the last runner of his/her team. The baton is handed over and passed forward to the new leader who sprints away, etc.

**Variation:** Run to music.

## 4. GAMES *(continued)*

### HURDLE GAME

Each team is given a pile of cardboard boxes. Marks are placed showing the points to which the boxes must be carried. The first runner carries his/her box to the first mark, returns and sends off the next runner with a hand slap. The second runner carries his/her box to the second mark, etc. The first round is finished when all the boxes have been distributed. In the following rounds the boxes are used as hurdles. Shuttle and turning relays are possible. In the last round the boxes are collected one by one and returned to the start.

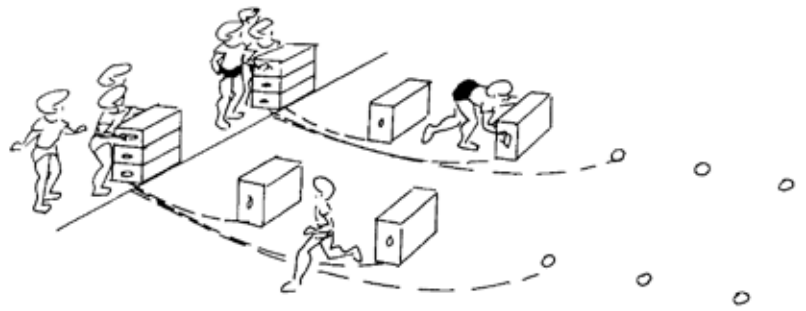

**Note:** The marks should be positioned in such a way that the boxes can be run over with a specific rhythm ("one-stride rhythm", "two-stride rhythm" etc.).

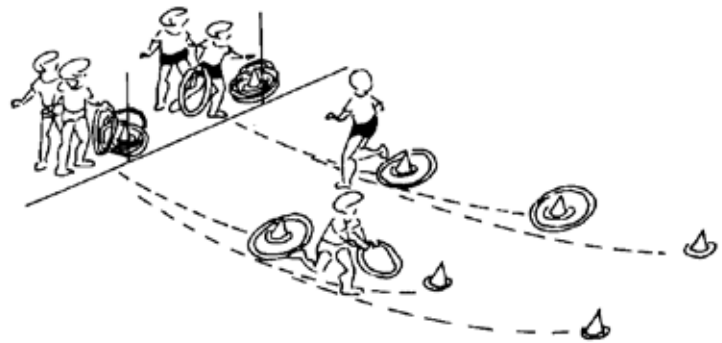

**Variation:** Cones can be set out instead of marks. In the first round the runners place rings over the cones. In the following rounds the runners hurdle the cones/rings.

### ENDURANCE GAME

Runners must complete a prescribed number of laps on a 200 - 400 metre cross country course. Each lap is interrupted by a throwing station. Runners are allowed to continue only when they hit the target. Runners who fail to hit the target after three throws must run a penalty lap.

**Variation:** Run in teams. The team can only continue when all members have hit the target or completed the penalty lap.

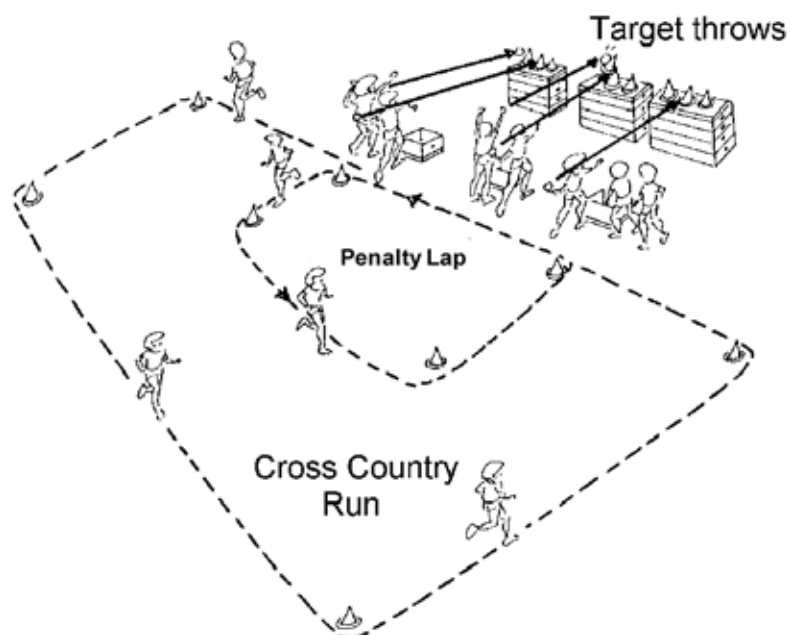



# SPRINTS





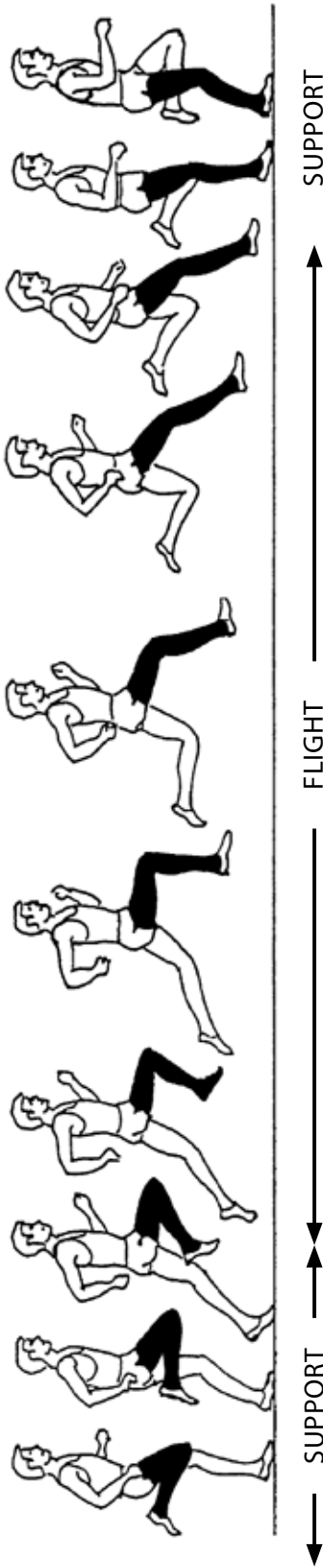

## Sprints– Whole Sequence

### Phase Description

Each stride comprises a **SUPPORT PHASE** (which can be divided into a front support phase and a drive phase) and a **FLIGHT PHASE** (which can be divided into a front swinging phase and a recovery phase).

- In the support phase the sprinter's body is decelerated (front support) then accelerated (drive).
- In the flight phase the free leg swings ahead of the sprinter's body and extends for the touchdown (front swing) while the other leg bends and swings to the sprinter's body (recovery).



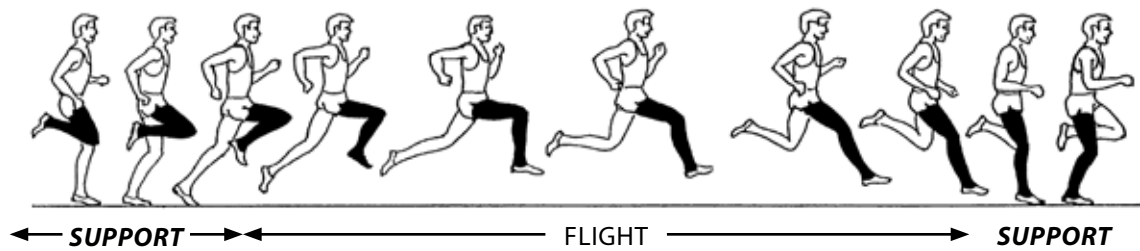

## SUPPORT PHASE

### *Front Support*

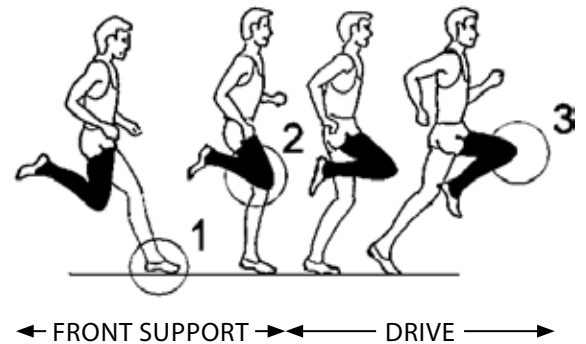

## Objective

To minimise deceleration at touchdown and to maximise forward drive.

## Technical characteristics

- Landing is on the ball of the foot. (1)
- Knee bend of the support leg is minimal during amortization; the swing leg is doubled up. (2)
- Hip, knee and ankle joints of the support leg are strongly extended at take off.
- Thigh of the swing leg rises quickly towards a horizontal position. (3)

### COACHES SHOULD:

- Observe that the athlete does not brake when the foot contacts the ground.
- Ensure that the support leg does not collapse.
- Observe the overall rhythm of the sprint.
- Observe one component of a phase at a time.

### HELP ATHLETES TO:

- Actively 'claw' the ground at touchdown.
- Run relaxed, naturally and lightly.
- Maintain visual focus ahead and use to run 'tall'.

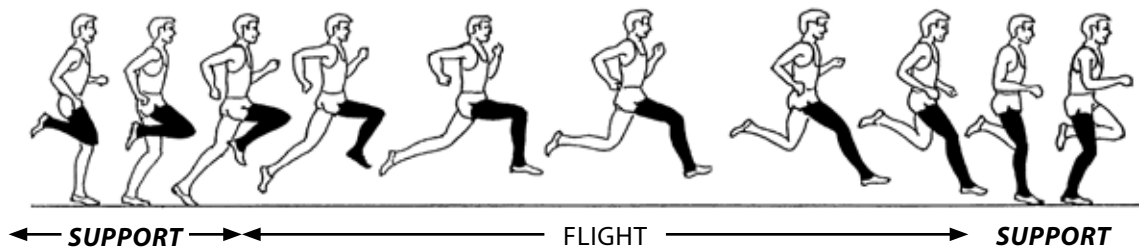

## SUPPORT PHASE

### *Drive*

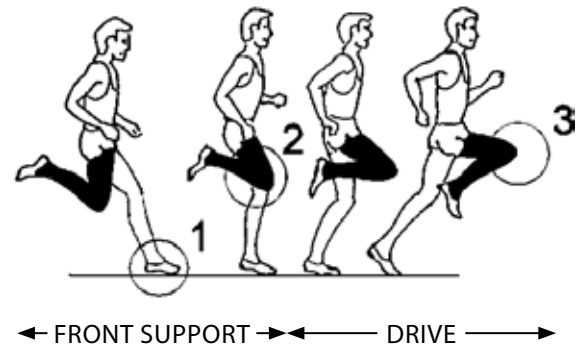

#### COACHES SHOULD:

- Ensure that the support leg does not collapse.
- Observe lower limb, joint and body actions and angles.
- Observe the arm action.

## Objective

To minimise deceleration at touchdown and to maximize forward drive.

## Technical characteristics

- Landing is on the ball of the foot. (1)
- Knee bend of the support leg is minimal during amortization; the swing leg is doubled up. (2)
- Hip, knee and ankle joints of the support leg are strongly extended at take off.
- Thigh of the swing leg rises quickly towards a horizontal position. (3)

#### HELP ATHLETES TO:

- Keep shoulders relaxed.
- Use a fast relaxed arm action emphasising the drive backwards.
- Run evenly and balanced.
- Maintain visual focus ahead.

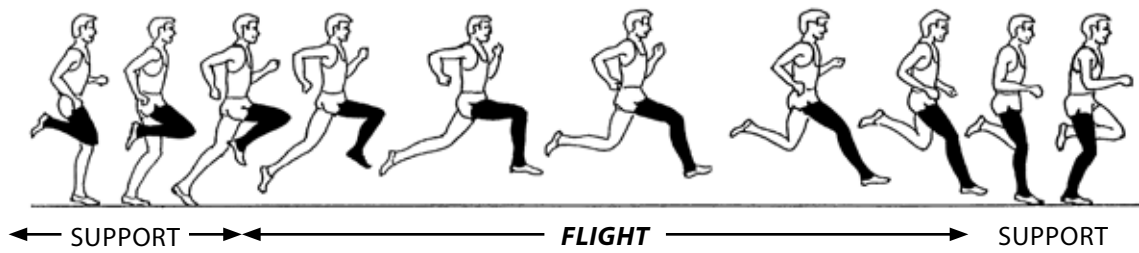

## FLIGHT PHASE

### *Recovery*



#### COACHES SHOULD:

- Observe from the side and front.
- Ensure that the heel comes quickly close to the sprinter's body.
- Use drills to develop the actions in the phases.

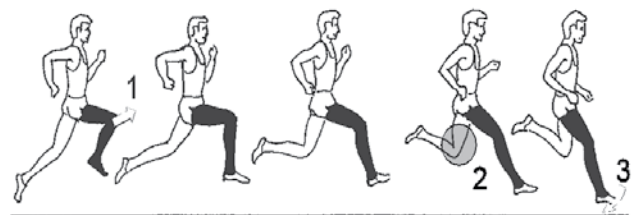

## Objective

To maximise the forward drive and to prepare for an effective foot plant at touchdown.

## Technical characteristics

- Knee of the swing leg moves forwards and upwards (to continue the drive and increase stride length). (1)
- Knee of the support leg flexes markedly in the recovery phase (to achieve a short pendulum). (2)
- Arm swing is active but relaxed.
- Next support leg sweeps backwards (to minimise the braking action at touchdown). (3)

#### HELP ATHLETES TO:

- Coordinate the support and flight phases.
- Keep trunk position upright.
- As the foot leaves the ground think 'Toe up, Heel up'.

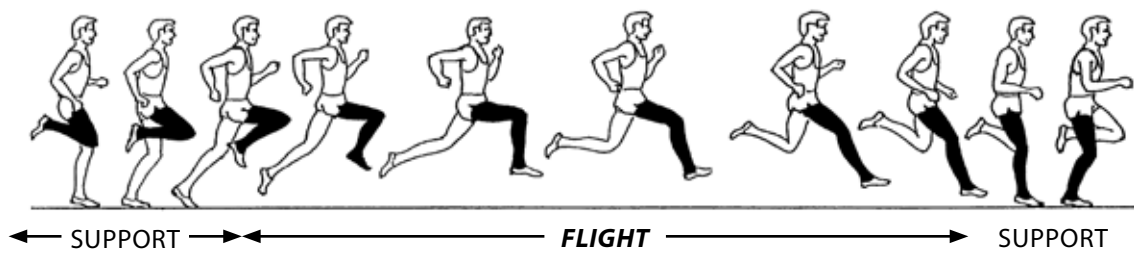

## FLIGHT PHASE

### *Front Swinging*



#### COACHES SHOULD:

- Observe from the side and front.
- Develop appropriate strength and elastic power.
- Use drills to develop the actions in the phases.
- Ensure that the foot is moving back relative to the body so braking forces are minimised at touchdown.



## Objective

To maximise the forward drive and to prepare for an effective foot plant at touchdown.

## Technical characteristics

- Knee of the swing leg moves forwards and upwards (to continue the drive and increase stride length). (1)
- Knee of the support leg flexes markedly in the recovery phase (to achieve a short pendulum). (2)
- Arm swing is active but relaxed.
- Next support leg sweeps backwards (to minimise the braking action at touchdown). (3)

#### HELP ATHLETES TO:

- Coordinate the support and flight phases.
- Use a fast relaxed arm action emphasising the drive backwards.
- Keep trunk position upright.
- Bring the thigh of the free leg to horizontal in the flight.

## STEP 1 BASIC EXERCISES

### OBJECTIVES:

To develop basic running skills.

#### TIPS:

- For high knees, "Thigh parallel to the ground."
- For heel flick, "Toe up, Heel up."
- Focus straight ahead and stride out smoothly at the end of the drill.

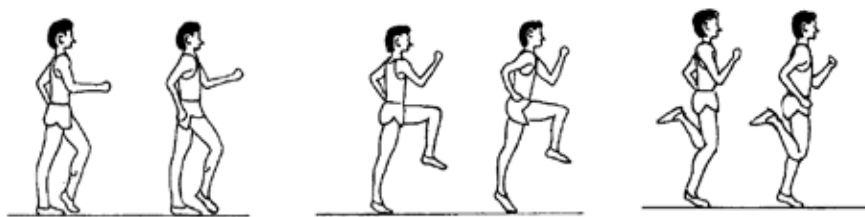

Use the basic exercises to complete the warm-up:

- Ankleing
- High Knees
- Heel Kick-up
- High Knees with extension

## STEP 2 BASIC DRILLS

### OBJECTIVES:

To develop sprinting skills and coordination.



- Combinations and Variations.
- Combinations and Transitions to sprinting (see figure).
- Arm Action Drills.
- Ins and Outs.

#### TIPS:

- Distance according to age and ability.
- Think, relaxed arms, "back, back".
- Focus straight ahead and sprint smoothly at the end of the drill.

## STEP 3 RESISTANCE RUNS

### OBJECTIVES:

To develop the drive phase and specific strength

#### TIPS:

- Do not exaggerate the resistance.
- Run tall and without 'leaning into' the resistance.
- Walk back on all drills.

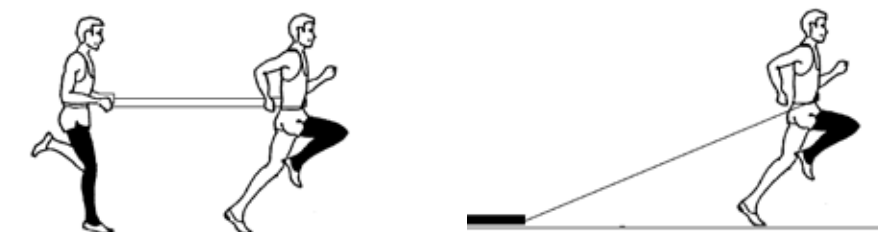

- Use the resistance of a partner or an implement.
- Do not exaggerate the resistance.
- Ensure full extension of support leg and short ground contacts.



## STEP 4 PURSUIT RUNS

### OBJECTIVES:

To develop reaction speed and acceleration.

#### TIPS:

- Lead runner, accelerate quickly and smoothly.
- Rear runner, focus on reacting to lead runner.
- Vary the starting pace.



- Use a stick or a rope (1.5 m).
- Jog in line.
- Front runner releases the stick (or rope) to initiate the pursuit.

## STEP 5 ACCELERATION RUNS

### OBJECTIVES:

To develop acceleration and maximum speed.

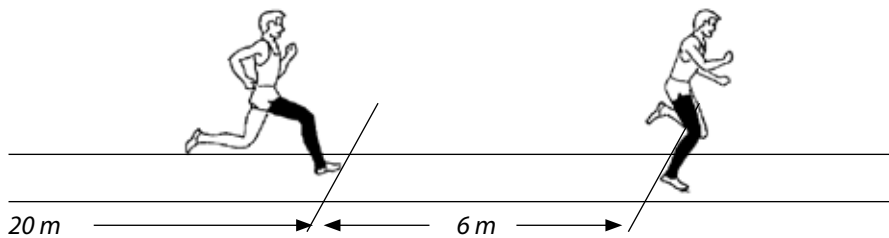

- Mark a 6 m zone.
- One partner waits at the end of the zone.
- Accelerate when the incoming partner enters the zone.

#### TIPS:

- Incoming runner should sprint in strongly.
- Outgoing athlete should react quickly.
- Gradually lengthen the strides with acceleration.

## STEP 6 FLYING '30' – 20 TO 30 METRES SPRINT

### OBJECTIVES:

To develop maximum speed.

#### TIPS:

- Maintain frequency throughout the speed zone.
- Keep arms fast and relaxed.
- Stop practice if cannot maintain speed.

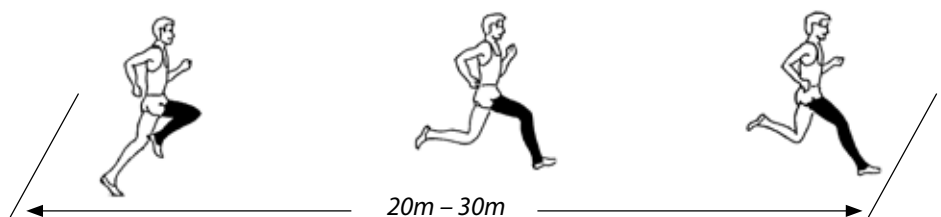

- Mark a zone of 20m to 30m – depending on the developmental age and experience of the athletes.
- Always use 30 m approach with maximal acceleration.
- Run through the zone at maximum speed.



# CROUCH START





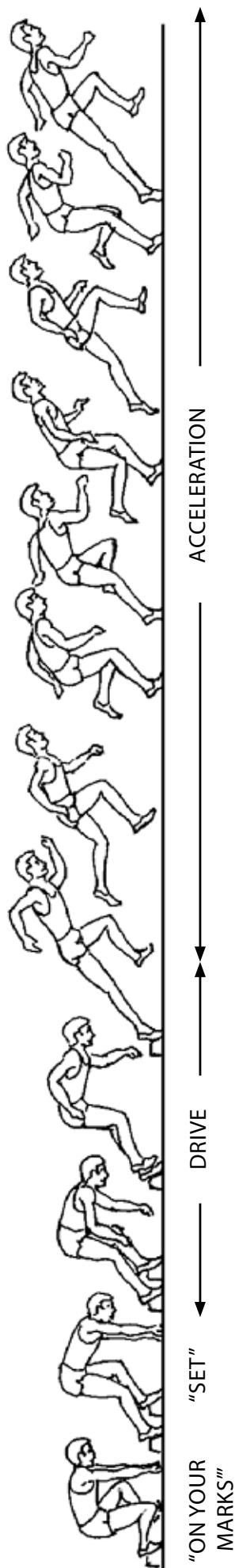

## Crouch Start– Whole Sequence

### Phase Description

The Crouch Start is divided into four phases: "ON YOUR MARKS" position, "SET" position, DRIVE and ACCELERATION.

- In the "on your marks" position the sprinter has set the blocks and assumed the initial position.
- In the "set" position the sprinter has moved to an optimal starting position.
- In the drive phase the sprinter leaves the blocks and takes the first strides.
- In the acceleration phase the sprinter increases speed and makes the transition to the running action.

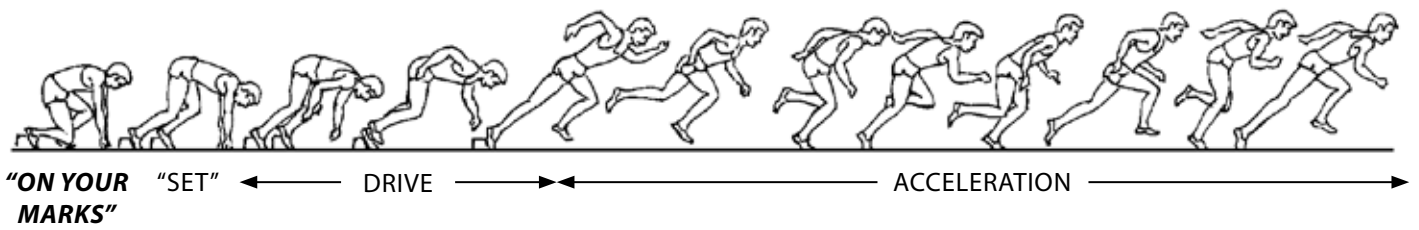

## BLOCK PLACEMENT AND ADJUSTMENT

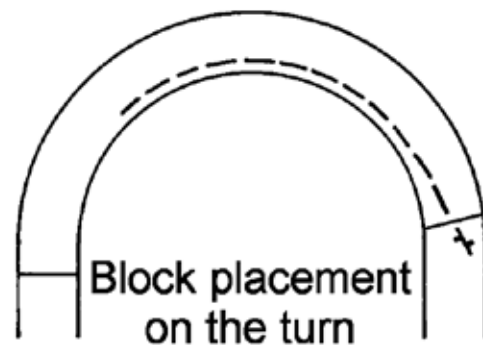
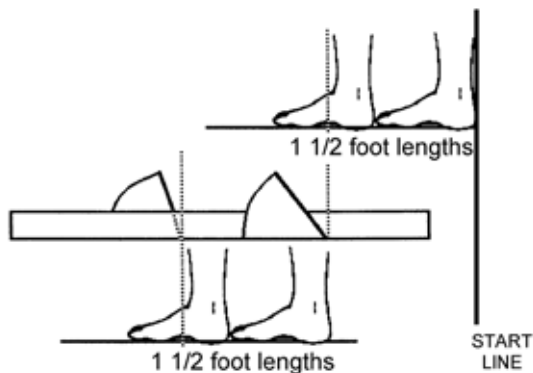
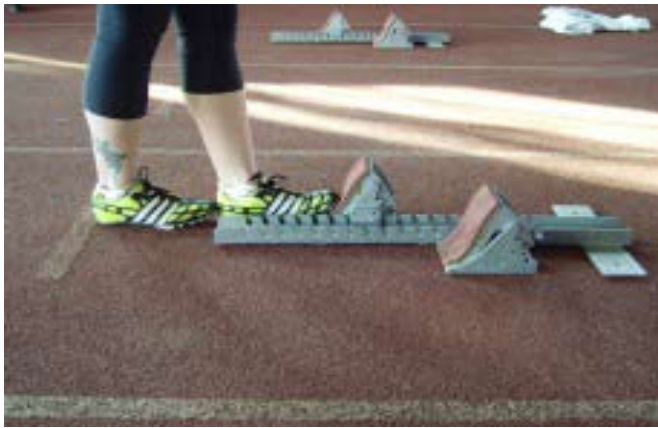

### Objective

To set the starting blocks to suit the sprinter's size and ability.

### Technical characteristics

- Front block is placed 1½ foot lengths behind the starting line.
- Rear block is placed 1½ foot lengths behind the front block.
- Front block is usually set flatter.
- Rear block is usually set steeper.

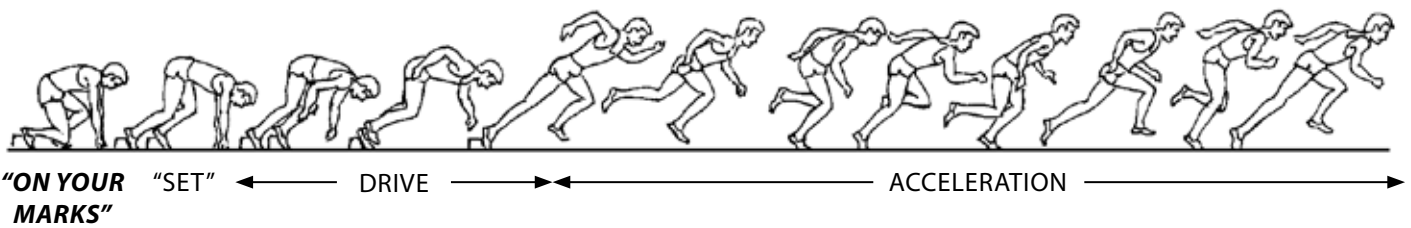

## “ON YOUR MARKS” POSITION



### COACHES SHOULD:

- Ensure that the blocks are appropriately set up for the athlete.
- Observe the athlete's posture including the head position.
- Check that the hand position is comfortable and correctly placed.



## Objective

To assume an appropriate initial position.

## Technical characteristics

- Both feet are in contact with the ground.
- Knee of the rear leg rests on the ground.
- Hands are placed on the ground, slightly more than shoulder-width apart, the fingers are arched.
- Head is in level with the back, eyes are looking straight down.

### HELP ATHLETES TO:

- Determine optimum block positions and spacing.
- Experiment with either leg in front to determine the 'strong' leg.
- Set up blocks in an efficient, confident and relaxed manner.
- Have a relaxed, focused attention on the starter's commands.

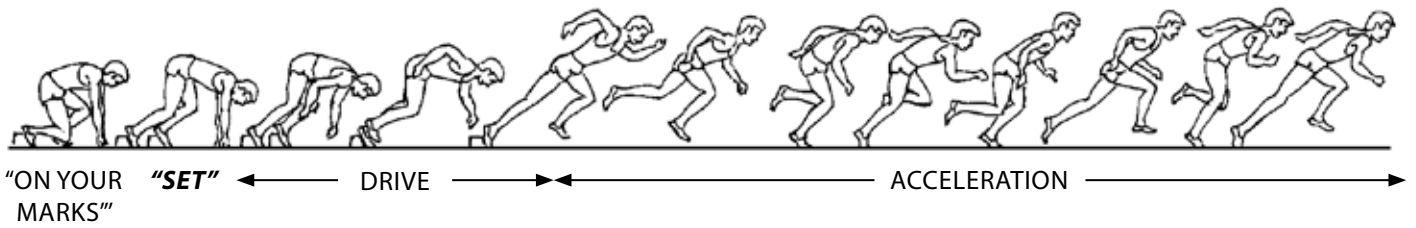

## "SET" POSITION

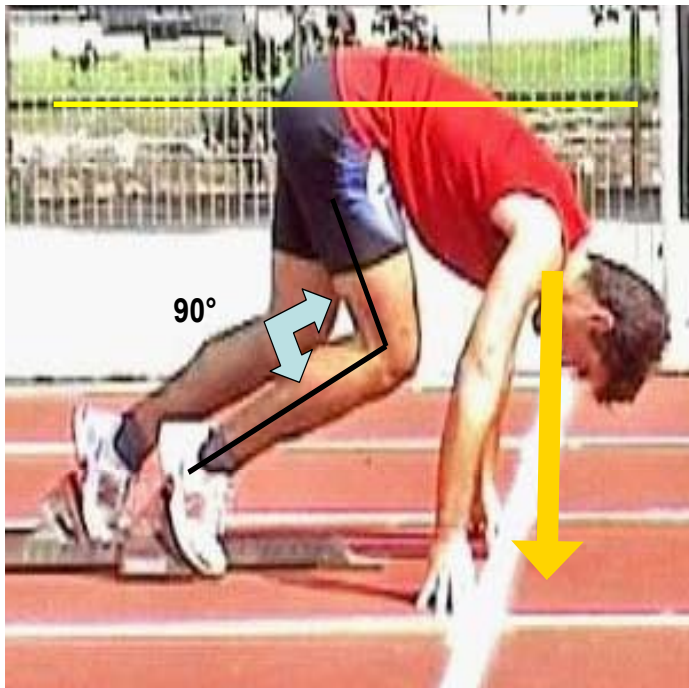

### COACHES SHOULD:

- Observe from the front and side.
- Observe the position of trunk and limbs.
- Ensure that athletes are stable.
- Confirm that the athlete's focus is on the sprinting from the blocks.

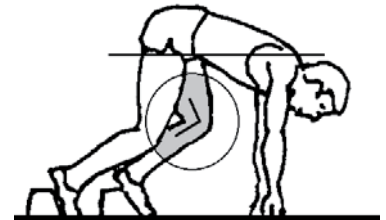

## Objective

To move into and hold an optimal starting position.

## Technical characteristics

- Heels press backwards.
- Knee of the front leg is at a 90° angle.
- Knee of the rear leg is at a 120°-140° angle.
- Hips are slightly higher than the shoulders, the trunk is inclined forward.
- Shoulders are slightly ahead of the hands.

### HELP ATHLETES TO:

- Raise the hips in a smooth controlled movement and position the shoulders over or ahead of the hands.
- Be prepared to sprint, not listen for the sound of the gun.
- Feel the feet pressure on the blocks.



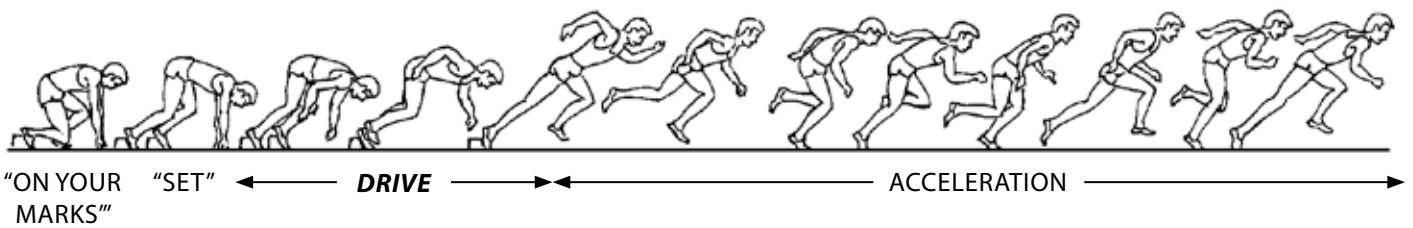

## DRIVE PHASE

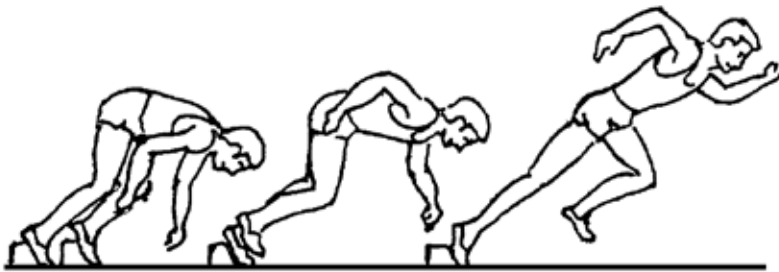

### Objective

To leave the blocks and to prepare for the first stride.

### Technical characteristics

- Trunk straightens and lifts as both feet press hard against the blocks.
- Hands lift from the ground together then swing alternately.
- Push of the rear leg is hard/short, the front leg's push is a little less hard but longer.
- Rear leg moves forwards rapidly while the body leans forwards.
- Knee and hip are extended during the drive.

#### COACHES SHOULD:

- Observe the speed of reaction to the gun and the sequence of movement.
- Observe the speed and extension of the knee and hip joints.
- Ensure that the athlete optimises the drive from the blocks.
- Observe that the arms move quickly into a coordinated balance to the legs.

#### HELP ATHLETES TO:

- Develop quick reactions to the gun through appropriate practices.
- Go on the 'B' of 'BANG'.
- Develop the power to move forcefully and explosively from the blocks.
- Pull the back leg through quickly.

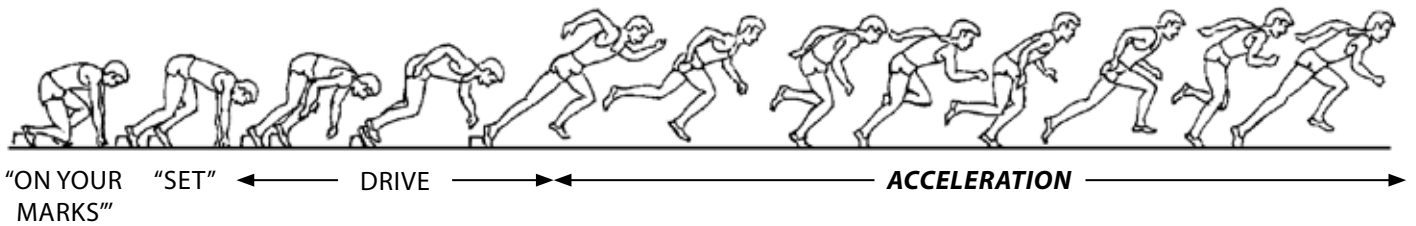

## ACCELERATION PHASE



### COACHES SHOULD:

- Observe the action of the limbs and position of the trunk and head.
- Observe the increase in stride length and frequency.
- Ensure that the athlete's transition into the sprinting action is smooth.



## Objective

To increase velocity and to make an efficient transition to the sprinting action.

## Technical characteristics

- Front foot is placed quickly onto the ball of the foot for the first stride.
- Forward lean is maintained.
- Lower legs are kept parallel to the ground during recovery.
- Stride length and stride frequency increase with each stride.
- Trunk straightens gradually after 20-30m.

### HELP ATHLETES TO:

- Accelerate with head in natural alignment and not suddenly look up from the gun.
- Quickly drive back against the ground while the body is leaning forwards.
- 'Drive', then sprint, or accelerate, then sprint.



## STEP 1 STARTS FROM DIFFERENT POSITIONS

### OBJECTIVES:

To improve concentration and acceleration.

#### TIPS:

- Which position feels best to accelerate out of?
- Be prepared to sprint and react quickly.
- Keep the body in natural alignment without 'looking up' too early.



- On a signal move into running position and accelerate quickly.
- Can be performed individually or in pairs (one athlete chases the other).

## STEP 2 STANDING START FROM A SIGNAL

### OBJECTIVES:

To develop concentration and reaction.

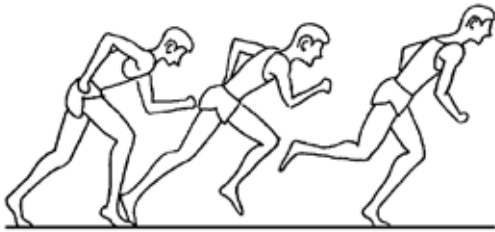

#### TIPS:

- Have the weight over the front foot.
- Be prepared to sprint and react quickly.
- Place a marker for the end of the acceleration of 10m-30m.

- Use a variety of starting signals: audible, visual and tactile.

## STEP 3 STANDING START VARIATIONS

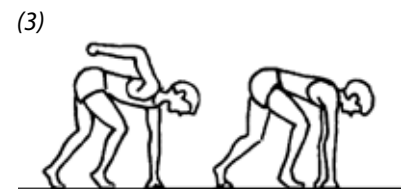
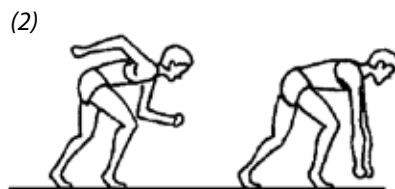

#### TIPS:

- Gradually 'shape' into the crouch start position and foot spacings.
- Place a marker for the end of the acceleration of 10m-30m.

### OBJECTIVES:

To practise raising the trunk and accelerating.

- Falling start without command. (1)
- Standing start from a forward leaning position. (2)
- Standing start from 3 or 4 point stances. (3)

## STEP 4 “ON YOUR MARKS” POSITION

### OBJECTIVES:

To introduce the “on your marks” position.



- Place and adjust the starting blocks.
- Explain and demonstrate key elements of the initial position.
- Practise with correction by coach or partner.

### TIPS:

- Make sure ‘strong’ foot is to the front.
- Hands to the line, for straight races, adjust for starts on bends.
- ‘Shut out’ other competitors.

## STEP 5 “SET” POSITION

### OBJECTIVES:

To introduce the “set” position.

### TIPS:

- Don’t rush the action.
- Feel the pressure on the blocks.
- Don’t hold the “set” position for too long.



- Explain and demonstrate the “set” position.
- Practise the change between “on your marks” and “set” positions without starting.
- Correction by coach or partner.

## STEP 6 WHOLE SEQUENCE



### OBJECTIVES:

To link the phases as a complete sequence.

- Start and sprint 10m - 30m without command and with command.
- Use different lanes, straight and bend starts, with and without opponents.
- Vary duration slightly between “set” and the gun.

### TIPS:

- Be ready to sprint, not waiting to hear the gun.
- Go on the ‘B’ of ‘BANG’.
- Accelerate smoothly.



# MIDDLE & LONG DISTANCE



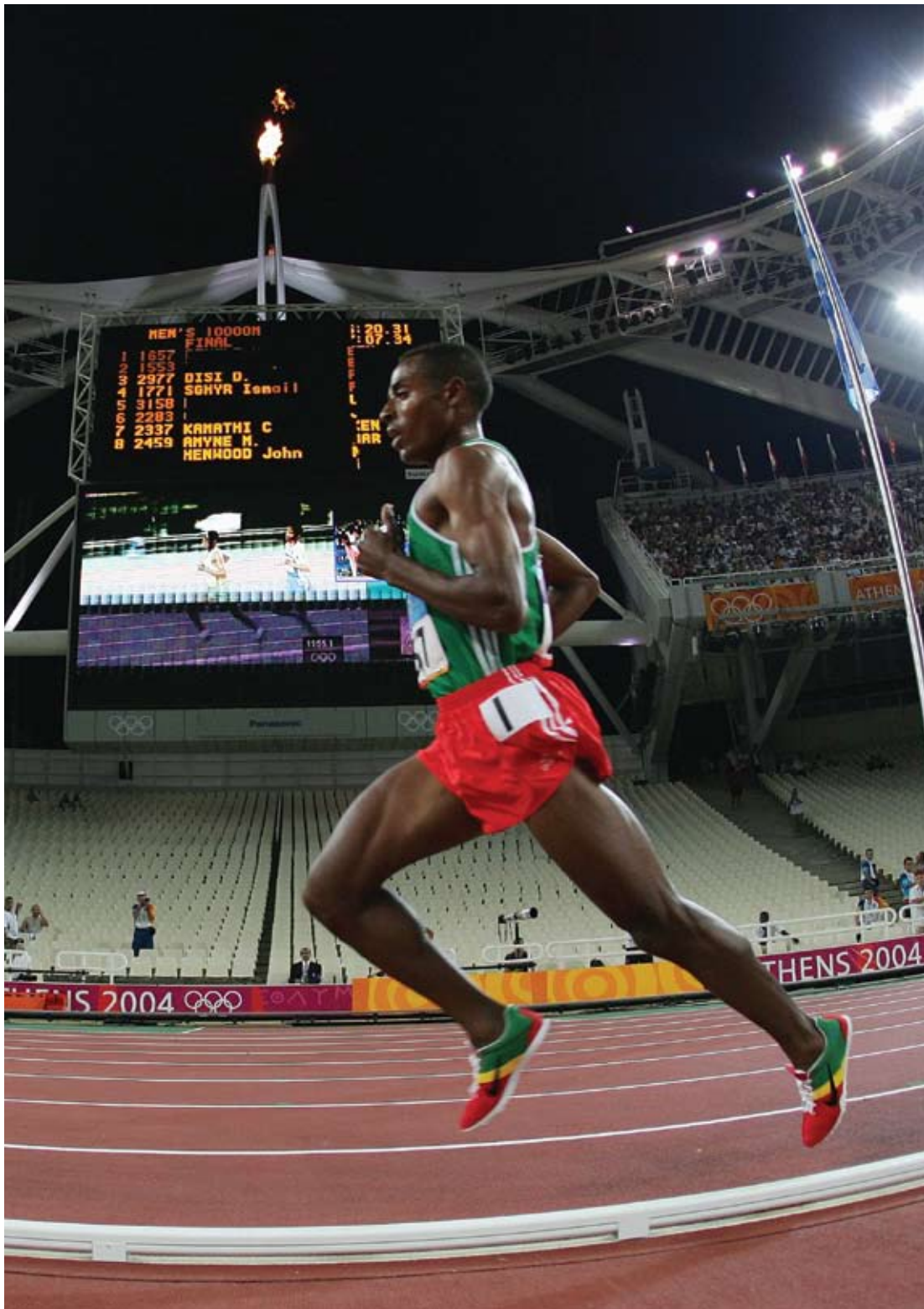



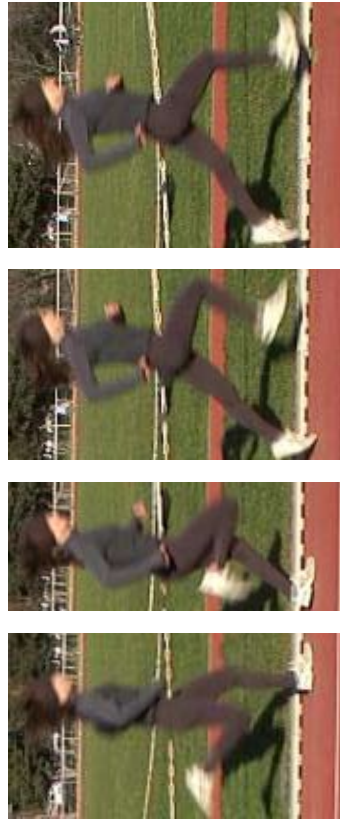
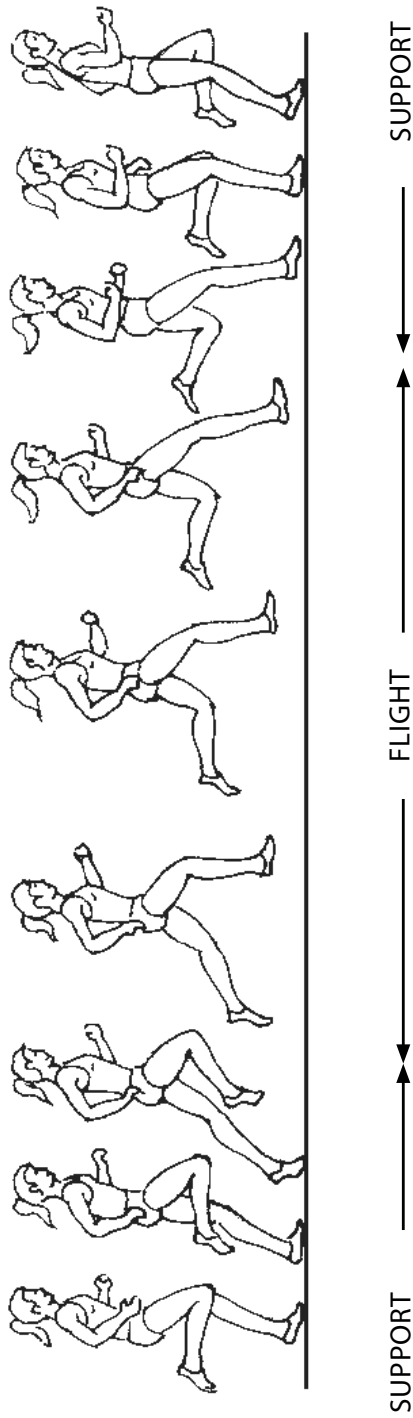

## Middle & Long Distance Running – Whole Sequence

### Phase Description

The structure of a middle and long distance stride is similar to a sprint stride with the following differences:

- Foot position at touchdown varies with the running pace.
- Free leg swings forwards with an open knee angle (the lower leg nearly parallel to the ground).
- Extension of the hip, leg and foot in the drive phase can be complete (middle distance) or incomplete (long distance).
- Knee lift is lower.
- Arm movement is less pronounced.

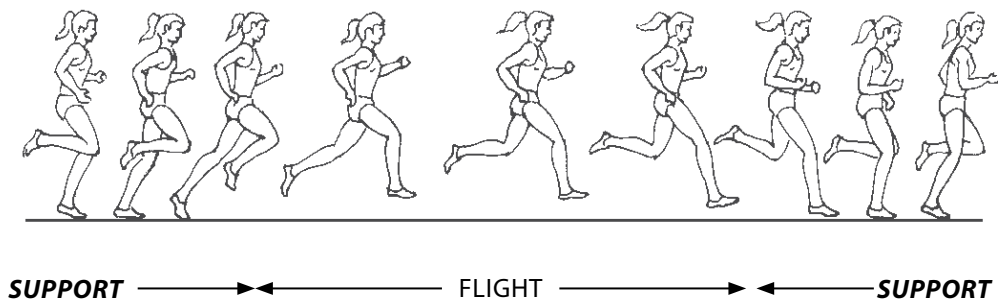

## FOOT PLACEMENT

LEFT FOOT

1

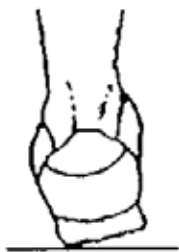

2

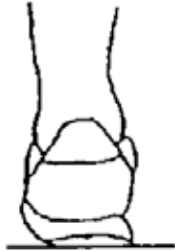

3

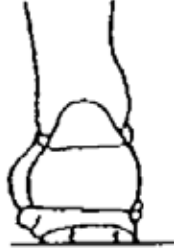

4

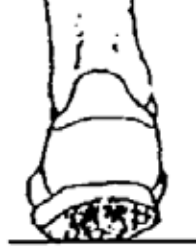

5

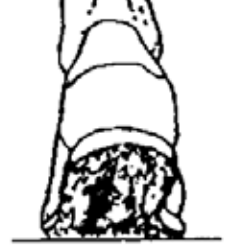

HEEL STRIKE

TOE-OFF

## Objective

To achieve an efficient foot action.

## Technical characteristics

- Each athlete will have their individual foot placement.
- In general:
  - Outside of the heel strikes first in longer, slower races. (1-3)
  - Middle or the forefoot strikes first in shorter, faster races. (4)
- Foot rolls over and off the tip of the shoe for toe-off. (5)

### COACHES SHOULD:

- Observe the action of the athlete's feet from the rear, side and front.
- Observe that the athlete's foot contacts the ground naturally and that the leg is not rigid or jarring at this moment.

### HELP ATHLETES TO:

- Run naturally and 'lightly'.
- Coordinate and relax the actions of the arms and legs.
- Focus on a natural rhythm through all phases.
- Adapt to the running surface.

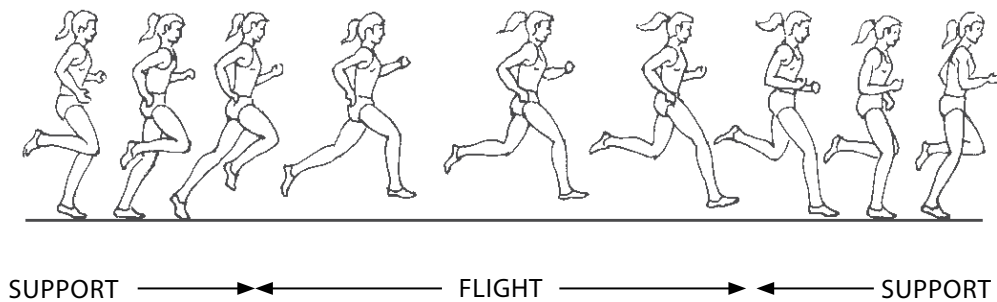

## STANDING START



### Objective

To start effectively from a standing position.

### Technical characteristics

- Front foot is placed up to the line with the other foot about shoulder-width behind.
- Weight is over the front foot.
- Arms are in position to synchronise immediately with the legs.
- Drive is off the front foot.

#### COACHES SHOULD:

- Observe the synchronised positions of arms and legs.
- Observe the extension of the hips, knees and ankles.
- Ensure that the athlete is able to quickly find the correct running rhythm.
- Observe one component of a phase at a time.

#### HELP ATHLETES TO:

- Coordinate and relax the actions of the arms and legs.
- Keep a balanced position after "On your marks".
- Drive strongly off the front leg and quickly find the correct running rhythm.

# TRAINING FOR MIDDLE & LONG DISTANCE

Middle and long distance runners, and all athletes, must develop general endurance as well as the endurance which is specific to the energy demands of their event. This endurance comes from correctly developing the energy systems. The training that is described in this section is also suitable for the race walking events.

There are three metabolic energy systems operating in our bodies. These energy systems operate continuously and it is how long and how hard we do whatever physical activity that determines which system contributes most. The longer the race the greater the emphasis on aerobic endurance, the shorter the race the greater the emphasis shifts to the lactate system endurance.

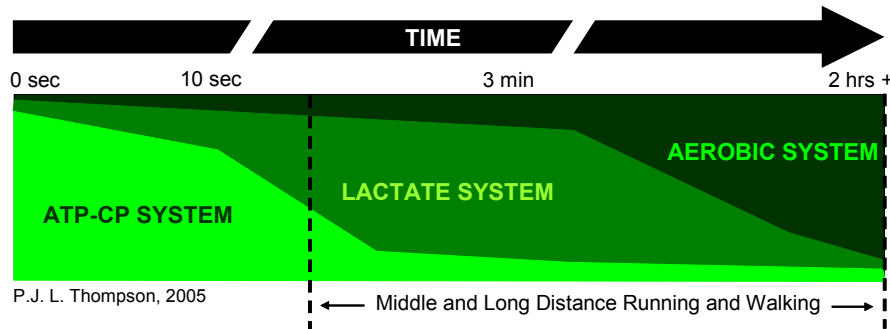

The most important types of running training for middle and long distance runners are:

- **Continuous Training:** Running without rest. Continuous training may be used to develop general endurance, specific endurance and for recovery. It usually takes place away from the track and provides a variety of pace, location and running surface in the athlete's training. Runs may be short, medium or long but it should be remembered that 'long' and 'short' are relative to the stage of development of the athlete and their fitness levels. The same distance might be a 'short' run for one athlete and a 'long' run for another athlete. The other type of continuous training which may be used throughout the year is 'Fartlek' training, where the athlete 'plays' with a variety of running speeds or rhythms.
- **Repetition Training:** Repetition training is breaking a total distance into smaller units which are repeated, hence repetitions, where the pace, distance and rest/recovery intervals and activity are prescribed. Usually done on the track but may be done in a park on grass or anywhere. Repetition training can be divided into two main types by pace or running rhythm: extensive and intensive. When the training emphasis is on general endurance, extensive repetition training is used; when the emphasis is on event specific endurance, particularly for the middle distance events, intensive repetition training is used.

Continuous and repetition training loads are usually defined by the following parameters:

- **Pace**, rhythm or running speed (min/km, min/mile, seconds per 400m lap, etc.)
- **Volume** can be described by the running distance (m, km, miles) or the running time (sec, min, hours) or by the number of repetitions or number of sets of repetitions.
- **Rest/Recovery** is the time, or interval, between different repetitions or sets of repetitions (sec, min or distance).

## Developing General Endurance

General endurance is developed mainly through continuous training, extensive repetition training and fartlek training. The pace used for these methods should be based on the athlete's running rhythms. These methods should be applied throughout the training year using the following guidelines:

**Note:** Continuous training runs should also be used throughout the year for recovery and regeneration.

- **Slow Continuous Runs** (Goal: recovery and regeneration)  
Pace: Easy rhythm; Volume: up to 30 minutes; Rest: not applicable.

- **Long Slow Distance Runs** (Goal: general endurance)  
Pace: Marathon rhythm and slower; Volume: 60-150 minutes; Rest: not applicable.
- **Medium Continuous Runs** (Goal: general endurance)  
Pace: Half-Marathon to Marathon rhythm; Volume: 30-60 minutes; Rest: not applicable.
- **Fast Continuous Runs** (Goal: general endurance)  
Pace: 10 Km to Half-Marathon rhythm; Volume: up to 10-45 minutes; Rest: not applicable.
- **Fartlek Runs** (Goal: aerobic and lactate system endurance)  
Pace: rhythmic 'speed-play'; Volume: 10-45 minutes, increases with the competition distance; Rest: not applicable but the 'easier' sections should still be active running.
- **Extensive Repetition Training** (Goal: emphasise aerobic endurance)  
Pace: 3000m to 10,000m rhythm; Volume: increases with the competition distance; Rest: depends on the individual runs in the sessions (see sample sessions).

Sample extensive repetition sessions:

- a) 2 x 10 x 200 m (3000m pace) [between reps = to running time, between sets: 5 min]
- b) 15 x 400 m (5000m pace) [between reps = to running time]
- c) 1 min, 2 min, 3 min, 2 min, 1 min (10,000m pace) [between runs = to running time]

**Note:** When using extensive repetition training the coach must monitor the pace carefully to ensure it stays at the prescribed rhythm. Running too fast during extensive repetition training is a common mistake.

Repetition training may also be divided into two main types according to the recovery activity that takes place during the 'intervals', the time between the faster repetition sections.

In standard **Repetition Training** the rest period between repetitions and sets may be passive, walking or easy running. But in the '**New Interval Training**', which is used because of its effectiveness in developing both the aerobic and lactate energy systems, the recovery in the intervals is a very active 'roll-on', running recovery. This roll-on, active running recovery will depend on the fitness and experience of the athlete. For an experienced athlete a 100m roll-on recovery, for example, is frequently less than 25-30 seconds. New interval training, then, is a specific type of repetition training where the training effect occurs in the interval between the faster sections. Only repetition training that has the training effect taking place in the interval should be called 'interval training'. To compare a classic repetition session of 15 x 400 (3000m pace) [90 secs] with new interval training:

Examples of new interval training sessions based on a classic repetition session:

- a) 15 x 400 (5000m pace) [100m roll-on]
- b) 3 x 5 x 400 (3000m pace) [100m roll-on & 3 mins]
- c) 3 x 5 x 400 (5000m, 3000m, 5000m, 1500m, 5000m) [100m roll-on & 800m roll-on].

All repetition training can, therefore, be varied by:

- **Repetitions** The total number of repetitions in a session - may be divided into sets.
- **Duration** Length of time or distance of one repetition
- **Intensity** Rhythm, pace, speed or velocity of the repetitions
- **Recovery** Time of the intervals between repetitions and sets
- **Recovery activity** From a walk to easy running or more active running, as in new interval training.

### Pace for Endurance Training

Coaches use 'pace' in planning endurance training. It means, "The running rhythm the athlete would use if they were racing that distance today - not their personal best".

Pace can be used as a guide for an athlete's running rhythms for either their continuous or repetition training. '3000m pace' means the running rhythm for this repetition will be the same rhythm as the athlete would have used mid-race if they had been racing in a 3000m race that day. Coaches planning training for running sessions should avoid using 'target times' for most of the year for their athlete's repetition training because these 'targets' do not reflect actual running rhythm. For example, an 82 seconds time for 400m might be an 'easy' effort for an athlete on a day when they are 'fresh'. The same time of 82 seconds may feel much harder, be a different rhythm and produce a different physiological response for that same athlete, if the athlete is very fatigued.

To give another example, '800m pace' means the running rhythm for the repetition will be the same rhythm as the athlete would have used if they had been racing an 800m race that day, the day of the actual training. This should be their 800m mid-race rhythm and not their '800m finishing pace'. We do not use, for example, a 36 seconds time for 200m since this might be an 'easy' effort for an athlete on a day when they are 'fresh'. The same time of 36 seconds may feel much harder and produce a different physiological response, or be unachievable, if the athlete is very fatigued from training, from other things in their life or if the weather is not good through wind, rain and/or temperature.

Using running rhythms and 'pace' means that the speed of the repetitions is adjusted each day to each athlete's fitness and energy levels. With training groups, using target times may fit one or two athletes in the group but not most of the athletes in the group. Using rhythms and 'pace' means that every athlete trains at their individual rhythm and level of performance, developing the fitness that they need.

### Developing Event Specific Endurance

Event specific endurance is developed mainly through intensive repetition training. The pace used for this method should usually be the athlete's running rhythm for that event, but may be based on 'goal pace', the target time for the competition distance very close to and during the competition period.

**Note:** The most intense 'intensive repetition' training (called **acidosis training**) leads to high concentrations of acid in the body and should be used carefully, if at all, with younger athletes.

- **Intensive Repetition Training** (Goal: event specific endurance)

Pace: Based on event specific rhythm; Volume: increases with the competition distance; Rest: depends on individual efforts in the session: passive, active or, in interval training, very active. Full recovery between sets.

Event specific endurance becomes important for athletes in the 'Specialisation' and 'Performance' stages of athlete development when it takes place in the specific preparation phase and competition period.

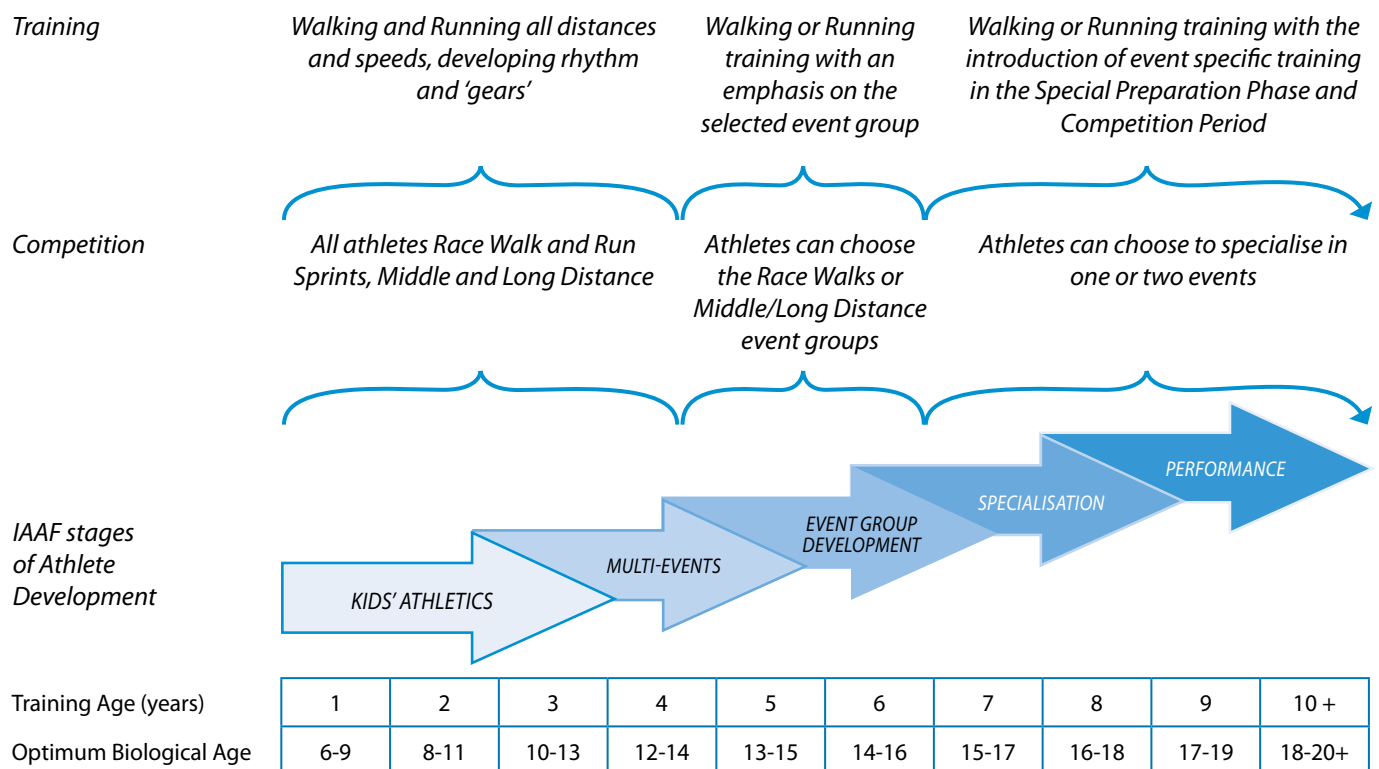

*The emphasis of training and competition during the IAAF stages of Athlete Development*

### Teaching and Training Technique

There are two basic technical skills in running, the athlete possessing the movement skills of:

1. a functional and technically efficient biomechanical **running action**, and
2. an awareness, effective control and expression of **running rhythm**.

In developing the skill of being aware of and controlling rhythm, experience has shown that athletes of all abilities have a greater or lesser sense of rhythm, just in the same way that some individuals are naturally more 'musical' than others. Experience has also shown that all athletes can develop their sense of rhythm, in the appropriate environment and if it is practised. The rhythms that coaches use are tied to perceptions related to in-race rhythm, not target times. A group of novice athletes might be set the challenge in training of, "I would like you to run at your own rhythm and run a 400m with the first 100m at 10,000m pace, the next 100m at 5000m pace, the next 100m at 3000m pace and the final 100m at 1500m pace. If the athletes do not have the experience to imagine how they would feel at the various distances they can be asked to run each 100m slightly faster than the one before and to finish as they would feel in the middle of a 1500m race.

Some coaches are doubtful that athletes can achieve this task and then are subsequently surprised when they observe that the athletes can actually find these 'gears'. Times are recorded but not given during repetitions. They may be given, occasionally, between repetitions since the emphasis is for each athlete to develop a self-awareness of their rhythm. This simple learning task is presented as 'A' (10,000m pace), 'B' (5000m pace), 'C' (3000m pace), 'D' (1500m pace) within a single repetition. Once they have done this, the athletes are asked, in the same session, to run for example 1200m with 100 metres at A, B, C, D, A, B, etc. The most difficult transition is usually from D to A but the athletes quickly learn this. It does not matter so much that the pace they are running at is accurately '10,000m' or '3000m' but that the differences, finding the 'gears', are exhibited and practised.

The 'Horwill 4-second Rule', devised by British coach Frank Horwill, states that an athlete who can run, for example, a 1500m in 4:00 (64 seconds/400m) should also be able to run 2:00 for 800m (60 seconds/400m), 3000m in 8:30 (68 seconds/400m), 5000m in 15:00 (72 seconds/400m) and 10,000m in 31:40 (76 seconds/400m). Using the 'Horwill 4-second Rule' we know that 800m, 1500m, 3000m, 5000m, 10,000m paces, and even half-marathon and marathon paces, should all potentially vary by 4 seconds per 400m, or by 1 second per 100m. This small difference is the order of variation we should observe in training.

Once athletes can achieve a simple A, B, C, D rhythm practice they can move on to much greater variety over different distances – e.g. B, D, A, C, D, etc. They can also practice this variety within and between repetitions during their training (see example c) in new interval training).

The teaching of the technical skill of running rhythm has a multi-dimensional response. Not only does it develop technique, it produces the optimal physiological response and may enhance the athlete's mental states. The control of the running is with the athlete and in training and races this is an essential technical and tactical skill.

### **Increasing the Training Load**

Increasing the training load within an annual training programme, or in successive training years, should be individualised, carefully planned and systematic. The following steps provide a guide:

Continuous Runs and Extensive Repetition Training:

- Step 1: Increase the number of weekly sessions of aerobic emphasis training.
- Step 2: Increase the volume of some of the training sessions (running distance/duration or number of efforts), maintaining variety and shorter recovery/regeneration runs.
- Step 3: Increase the pace (while decreasing the running distance/duration or number of efforts).
- Step 4: Adapt the pace and running rhythms individually.

Intensive Repetition Training:

- Step 1: Increase the volume of a session by adding sets (maintaining the same distance and pace of the efforts in the sets).
- Step 2: Increase the volume of some sessions by increasing the length of the efforts (maintaining the number and pace).
- Step 3: Increase the intensity (pace and running rhythm) of the efforts.
- Step 4: Decrease the rest between efforts or, with new interval training, look for improved speed in roll-on recoveries.

## STEP 1 RUNNING DRILLS

### OBJECTIVES:

To develop basic running skills and coordination

#### TIPS:

- For heel flick, "Toe up, Heel up."
- For high knees, "Thigh parallel to the ground."
- Focus straight ahead and stride out smoothly at the end of the drill.

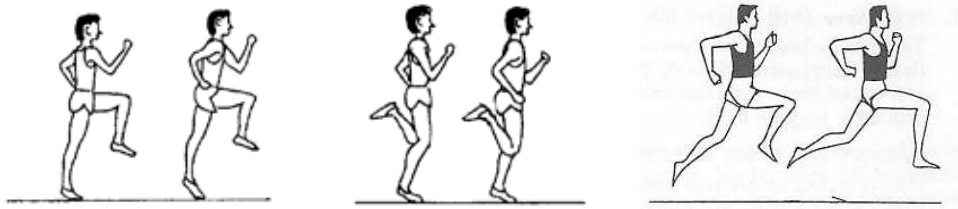

- Perform running drills over 20m-60m
- Emphasise correct action and frequency of movement:
- At the end of each drill immediately run out for 20m.
- Heel Flick
- High Knees
- Striding with High Knees

## STEP 2 STANDING START

### OBJECTIVES:

To develop reaction, coordination and acceleration from standing start.

#### TIPS:

- Use the rear foot lightly to assist stability.
- Don't bend too low.
- Focus and run off the line, don't listen for the gun.

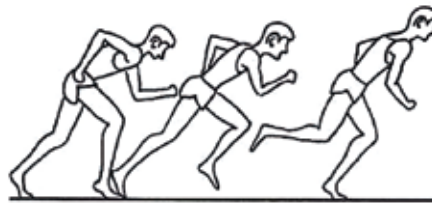

- Stand about 2m behind the start line.
- "On your marks", place one foot to the start line
- Other foot about shoulder width behind.
- Slight lean forward - weight on front foot.
- Arms synchronised with legs.
- At the 'gun', drive is off the front foot.

## STEP 3 RESISTANCE RUNS

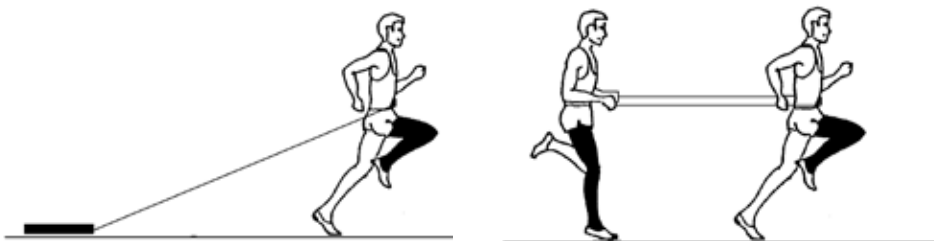

### OBJECTIVES:

To develop the drive phase and specific strength.

- Use the resistance of a partner or an implement.
- Do not exaggerate the resistance.
- Ensure full extension of support leg and short ground contacts.

#### TIPS:

- Do not exaggerate the resistance.
- Run tall and without 'leaning into' the resistance.
- Walk back on all drills.



## STEP 4 PURSUIT RUNS



### OBJECTIVES:

To develop reaction speed and acceleration.

- Use a stick or a rope (1.5 m).
- Jog in line.
- Front runner releases the stick (or rope) to initiate the pursuit.

### TIPS:

- Lead runner, accelerate quickly and smoothly.
- Rear runner, focus on reacting to lead runner.
- Vary the starting pace naturally.

## STEP 5 FLYING '30' – 10 TO 30 METRES SPRINT

### OBJECTIVES:

To develop maximum speed.

### TIPS:

- Maintain frequency throughout the speed zone.
- Keep arms fast and relaxed.
- Stop practice if cannot maintain speed.

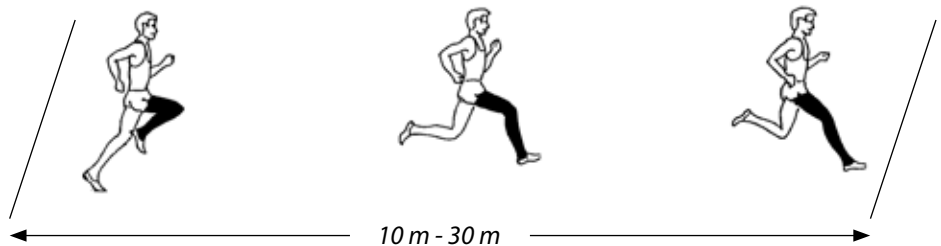

- Mark out an acceleration zone of 30 m and a 'speed' zone of 10 m-30 m.
- Accelerate maximally from a standing start position to be at maximal speed before the 'speed' zone.
- Run through 'speed' zone at maximal speed. Allow for full recovery, at least 2 minutes.

## STEP 6 RUNNING RHYTHM

### OBJECTIVES:

To develop changes in running rhythm and control of these changes.

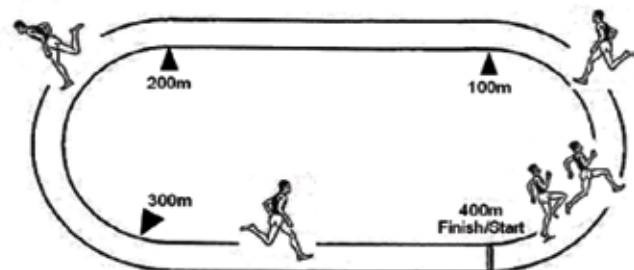

### TIPS:

- Athletes should not wear watches.
- Feel the running rhythm.
- Focus on your own rhythm and ignore other athletes on the track.

- Individual runs.
- Running rhythms should vary. Example 400m: 100m at 5000m pace, then 100m at 3000m pace, 100m at 1500m pace and 100m at 800m pace – mid-race pace not finishing pace.
- Progress, do same rhythm for 3 laps.
- Creatively use rhythms to develop 'gears'.



# RELAYS





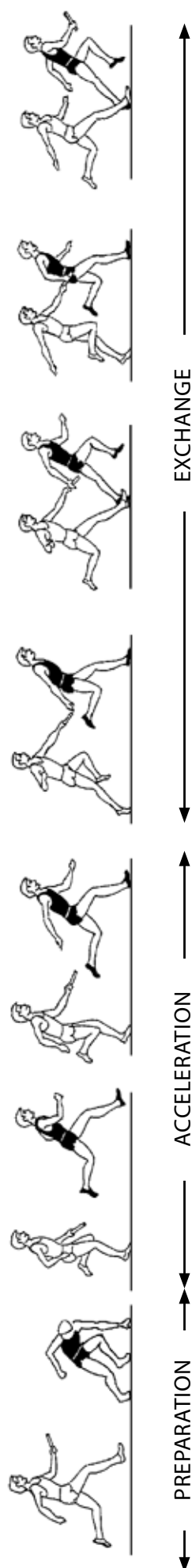

## RELAYS *NON-VISUAL EXCHANGE* – Whole Sequence



### Phase Description

The non-visual exchange is divided into three phases: PREPARATION, ACCELERATION and EXCHANGE.

- In the preparation phase the incoming runner maintains maximum speed and the outgoing runner assumes a starting position.
- In the acceleration phase the runners synchronise their speed by maintaining maximum speed
  - (incoming runner) and maximising acceleration (outgoing runner).
  - In the exchange phase the baton is passed, with an appropriate technique, as quickly as possible.

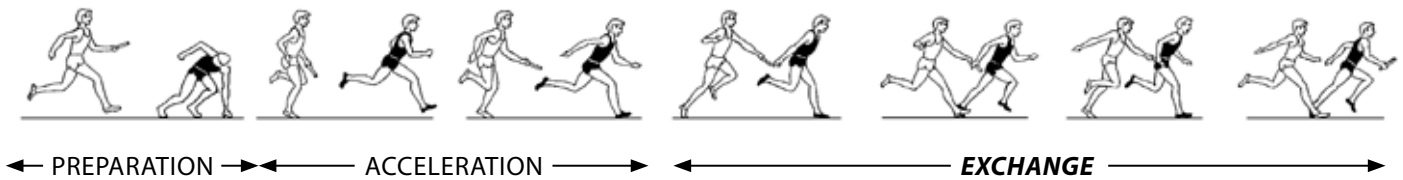

## ALTERNATE EXCHANGES

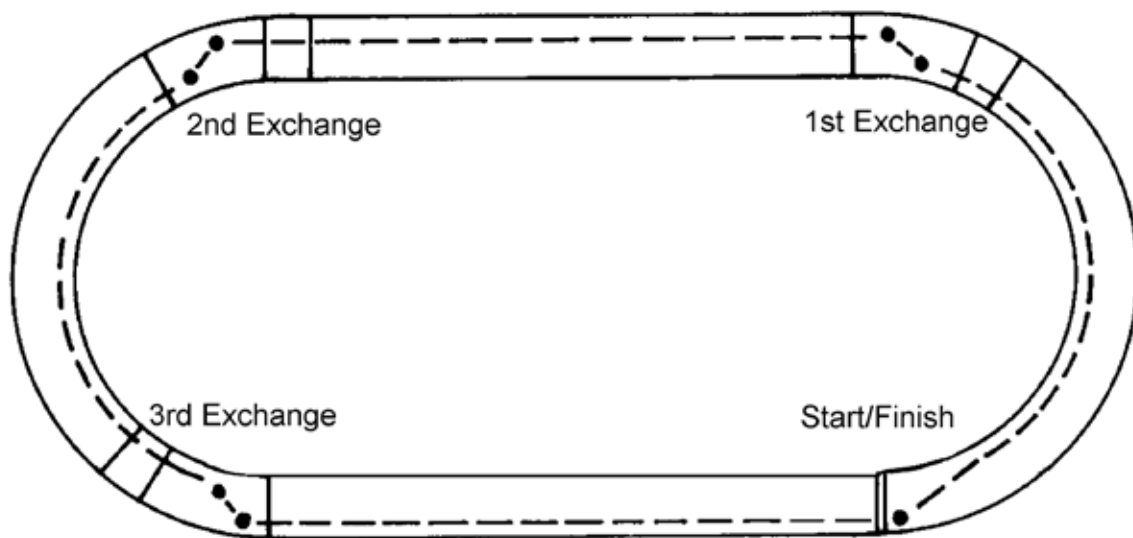

### Objective

To maximise the speed of the baton over 400 metres by minimising the distance run on each lane.

### Technical characteristics

- First or 'leadoff' runner carries the baton in the right hand and approaches the second runner from the inside of the lane ('inside exchange').
- Second runner receives the baton in the left hand and approaches the third runner from the outside of the lane ('outside exchange').
- Third runner receives the baton in the right hand and approaches the fourth or 'anchor' runner from the inside of the lane ('inside exchange').
- Fourth runner receives the baton in the left hand.

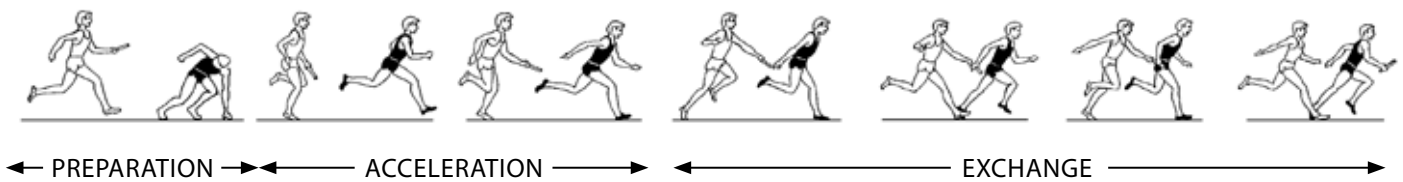

## ZONES AND CHECK MARKS

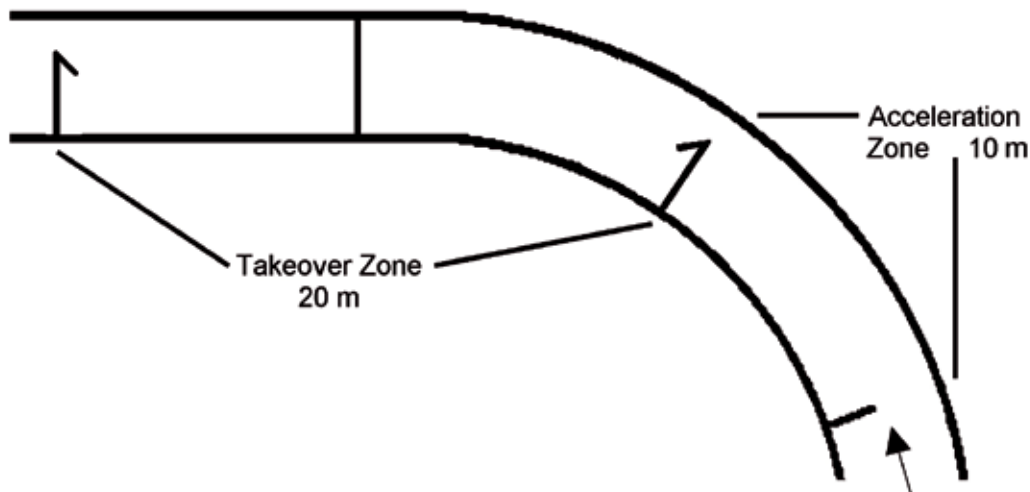

### Objective

To make a legal and efficient exchange.

### Technical characteristics

- Baton must be exchanged within the 20 m exchange zone.
- Outgoing runner may wait within the 10 m acceleration zone.
- Check mark is placed on the ground before the acceleration zone to indicate when the outgoing runner should start.
- Check mark will usually be 15-25 foot-lengths from the start of the acceleration zone on the side of the lane upon which the incoming runner will approach.

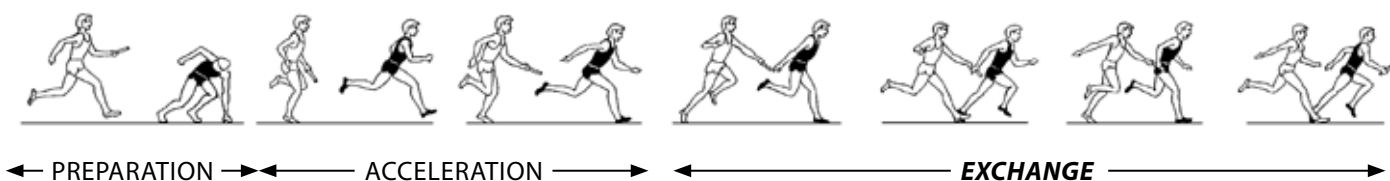

## ALTERNATE EXCHANGES

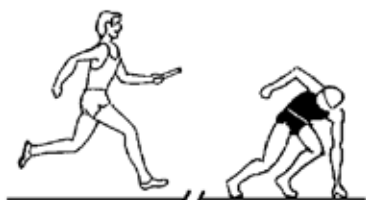

### COACHES SHOULD:

- Observe that the incoming athlete's sprinting is optimal.
- Observe the outgoing athlete's starting posture.
- Ensure that the outgoing athlete has placed the check mark in the correct place.

## Objective

To maintain maximum speed (Incoming runner).

To assume a starting position and start at the optimum moment (Outgoing runner).

## Technical characteristics

- Incoming runner approaches at maximum speed.
- Outgoing runner is positioned on the balls of the feet, knees bent, leaning forward.
- Outgoing runner looks at the check mark and starts when incoming runner reaches it.

### HELP ATHLETES TO:

- Determine the optimum position of the check mark
- Prepare for the race and exchange in a relaxed manner.
- Develop stability, consistency and confidence in the starting position for outgoing athletes.
- Use the incoming athlete 'hitting' the check mark as the 'gun'.



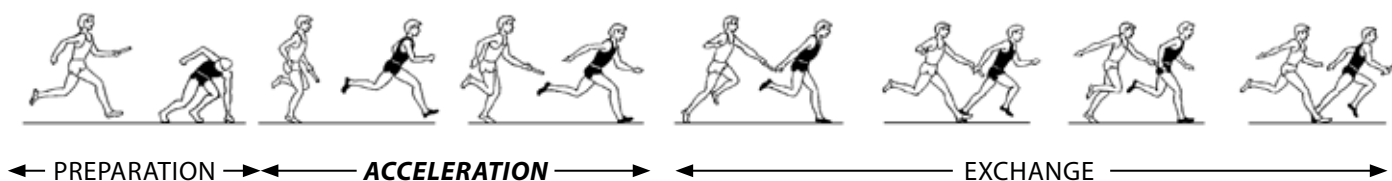

## ACCELERATION PHASE



### Objective

To maintain maximum speed and give the correct command for exchange (Incoming runner).

To accelerate in a controlled manner (Outgoing runner).

### Technical characteristics

- Acceleration of the outgoing runner must be consistent.
- Incoming runner gives a verbal command for the outgoing runner to receive the baton as the exchange distance is approached.
- Outgoing runner extends the receiving arm backwards (according to the exchange technique used) and the incoming runner reaches forwards.

#### COACHES SHOULD:

- Observe from the side, standing at least 30m back from the track.
- Ensure that both athletes maintain a forward visual focus.
- Observe the actions of the outgoing athlete and when the receiving hand comes back.

#### HELP ATHLETES TO:

- “Run through the zone”, for incoming athletes.
- Accelerate with head in natural alignment, for outgoing athletes.
- Focus visually down the track, for the outgoing athlete, “Don’t look back”.

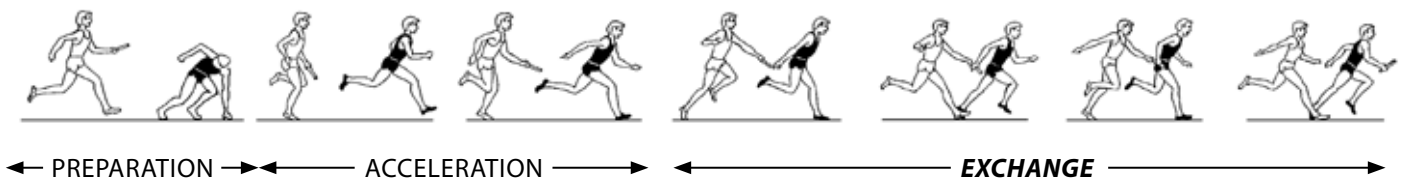

## EXCHANGE PHASE



### Objective

To pass the baton safely and quickly.

### Technical characteristics

- Incoming runner focuses on the outgoing runner's hand.
- Incoming runner pushes the baton into the outgoing runner's hand.
- Outgoing runner grips the baton as soon as contact is felt.
- Both runners stay on their side of the lane during the exchange.
- Incoming runner must stay in the lane until all exchanges are completed.

#### COACHES SHOULD:

- Observe from the front and side.
- Ensure that the athletes synchronise their speeds for the exchange.
- Observe where the exchange takes place within the zone and how far apart the athletes are.

#### HELP ATHLETES TO:

- Develop confidence in their check marks and the exchange technique selected.
- Understand that the outgoing athlete's responsibility is to provide a stable 'target' for receiving the baton.
- Understand that the incoming athlete has the greater responsibility for an effective exchange.

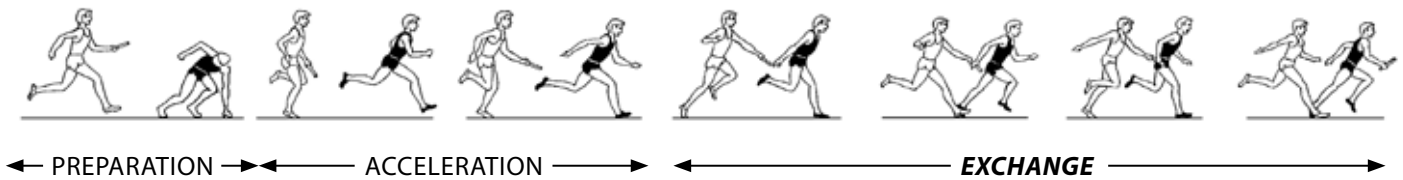

# PASSING TECHNIQUES

## *Push Pass Technique*

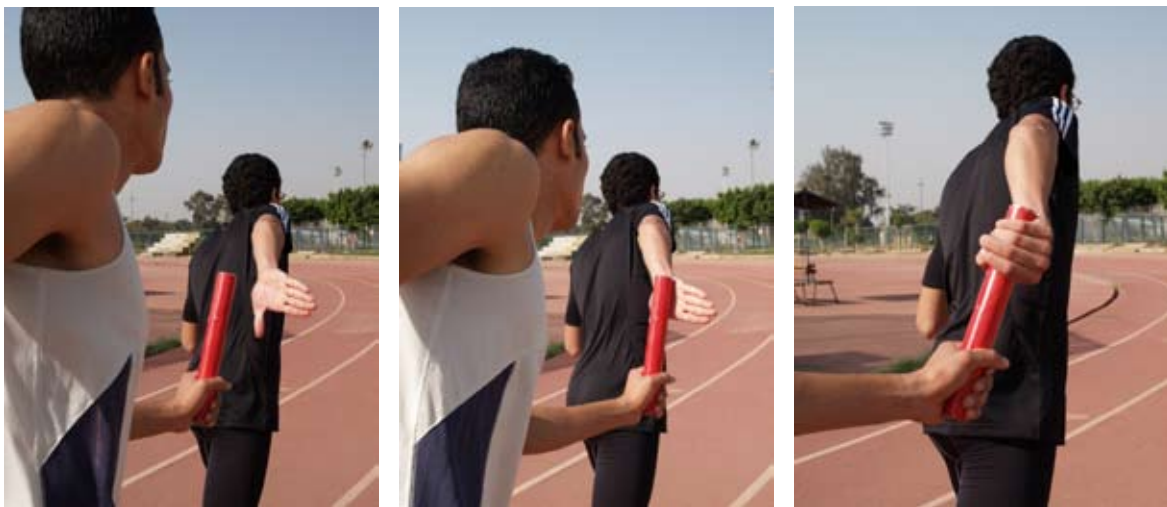

## Objective

To pass the baton safely and quickly.

## Technical characteristics

- Outgoing runner's arm is extended backward with the palm of the hand in a vertical position and the thumb pointing downwards.
- Incoming runner pushes the baton horizontally forward and places the top of the vertically held baton across the palm of the outgoing runner's hand.
- Distance between runners should be 1m or more.

### HELP ATHLETES TO:

- Develop confidence in their check marks and the push pass.
- Accept outgoing athlete's responsibility to provide a stable 'target' for receiving the baton.
- Push the baton forwards as incoming runner in a natural sprinting action.

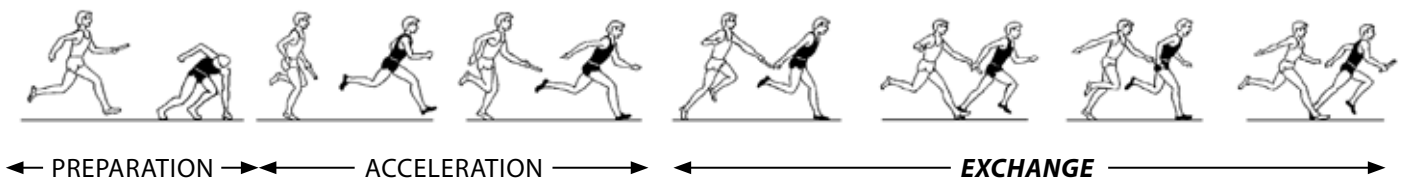

# PASSING TECHNIQUES

## *Upsweep Technique*

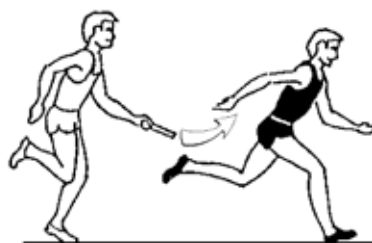

### COACHES SHOULD:

- Observe the outgoing athlete's hand position.
- Ensure that the outgoing athlete has placed the check mark in the correct place.

## Objective

To pass the baton safely and quickly.

## Technical characteristics

- Outgoing runner's hand is extended backward at hip level.
- Incoming runner moves the baton upwards between the outgoing runner's widely spread thumb and first finger.
- Distance between runners is 1 m or less.
- A relatively safe technique

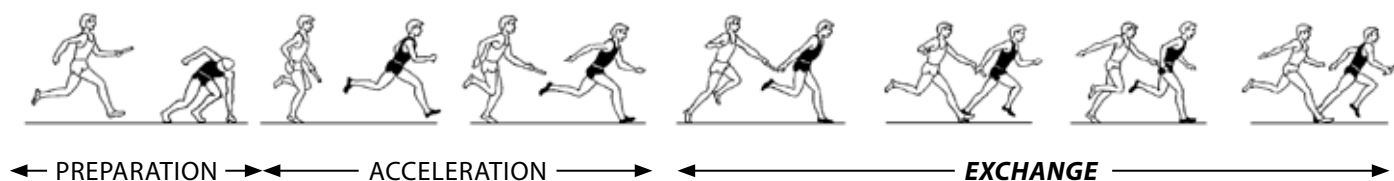

## EXCHANGE POINT

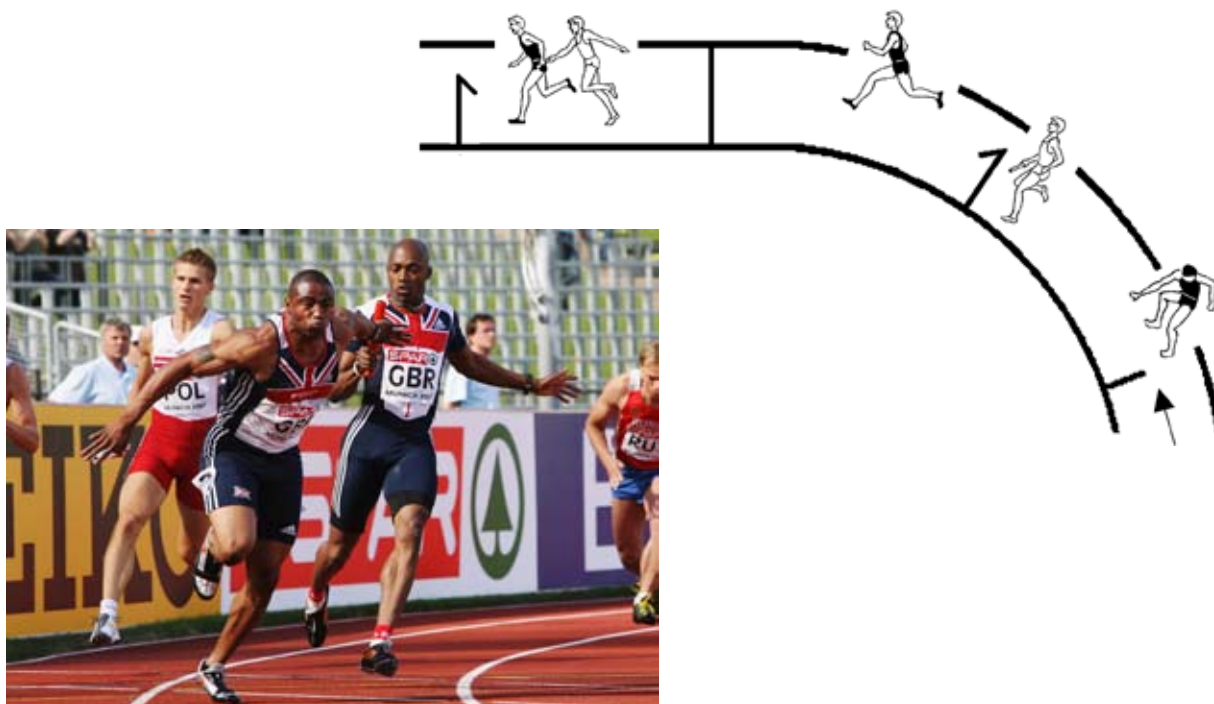

### Objective

To exchange the baton at optimum speed.

### Technical characteristics

- Runners synchronise their speed within the 30 m of the acceleration and exchange zone.
- Optimum exchange point for beginners is the middle of the 20 m exchange zone.
- More experienced athletes should move the exchange point to the optimal part of the exchange zone.
- Correct check mark and consistent acceleration by the outgoing runner are the keys to a successful exchange.

# 4 x 400m VISUAL EXCHANGE



## Objective

---

To ensure a safe and quick exchange of the baton.

## Technical characteristics

---

- Outgoing runner faces the inside of the track and holds the left arm out to receive the baton.
- Outgoing runner accelerates to match the speed of the incoming runner.
- Incoming runner holds the baton upright with the right hand and reaches towards the outgoing runner.
- Outgoing runner takes the baton with the left hand and changes it immediately to the right hand.
- The main responsibility for an effective exchange in the 4 x 400m Relay is with the outgoing athlete.



## STEP 1 INTRODUCTION TO THE VISUAL EXCHANGE

### OBJECTIVES:

To introduce the visual exchange.

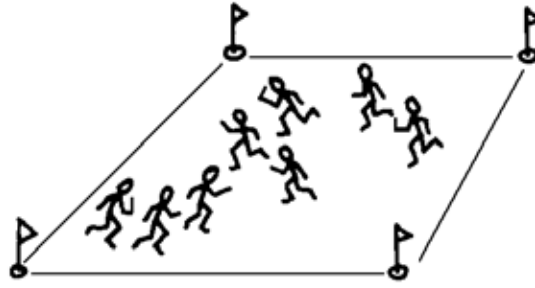

### TIPS:

- Run naturally when carrying the baton.
- Outgoing runner should 'take' the baton.

- Group moves randomly within a 40 m x 40 m area, one baton for every two athletes.
- Pass batons from the front, side and rear.
- Work in pairs, practise visual exchanges within a 20 m exchange zone.

## STEP 2 INTRODUCTION TO THE NON-VISUAL EXCHANGE



### OBJECTIVES:

To introduce the non-visual exchange

- Work in pairs, take it in turn to pass and receive baton at walking then jogging speed.
- Introduce push pass and upsweep passing techniques.
- Repeat in groups of four, passing right-left-right-left.

### TIPS:

- Walk, jog and run naturally, looking ahead.
- Incoming runner gives command for outgoing athlete's hand to come back.
- Provide a stable target.

## STEP 3 NON-VISUAL PASSES AT INCREASED SPEED

### OBJECTIVES:

To adapt passing technique to a higher level of speed.

### TIPS:

- Sprint naturally, keep looking ahead.
- Say "hand" three or more steps before you need to.
- Grip the baton firmly once received, "Don't snatch or grab".

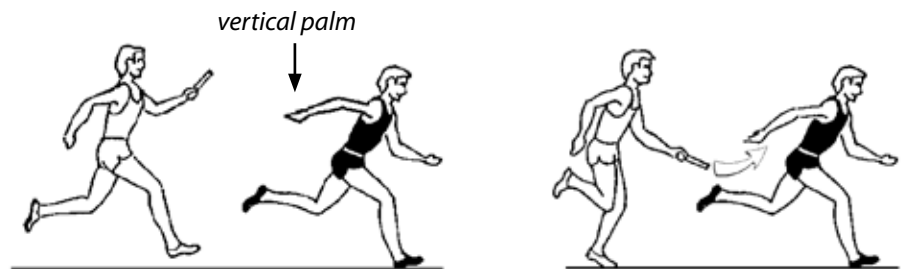

- Work in pairs.
- Pass the baton at a medium to fast speed over 50-70 m (2-3 repetitions).
- Use both push pass and upsweep passing techniques.



## STEP 4 CHECK MARK AND STARTING POSITION

### OBJECTIVES:

To introduce the preparation phase of the non-visual exchange.

#### TIPS:

- Outgoing athlete 'goes' when the athlete hits the check mark.
- Incoming runner runs 'through' the exchange.
- "Never look back".

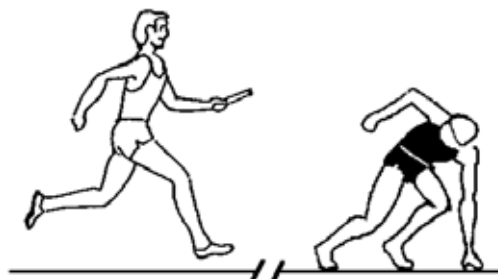

- Set check mark and practise starts from the starting position.
- Use various starting positions (standing, then one handed support).
- Incoming runner approaches at maximal speed.

## STEP 5 TEST AND COMPETITION

### OBJECTIVES:

To adapt exchange technique to competition speed and conditions.

#### TIPS:

- Your race is "one lane wide".
- Sprint maximally into the exchange.
- Accelerate maximally away from the incoming athlete.

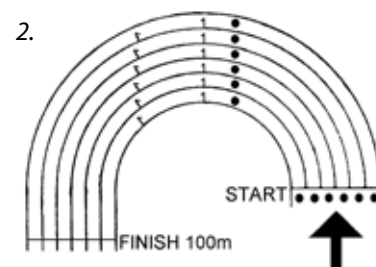
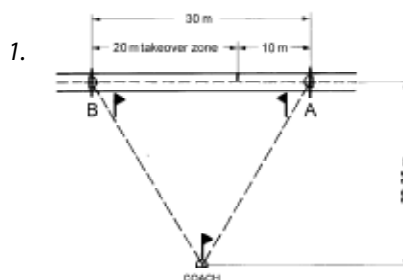

1. Speed of the baton: Measure the time the baton needs to travel from A to B. (1)
2. Competition in pairs: the faster pairs use the (longer) outside lanes. (2)

## STEP 6 WHOLE SEQUENCE



### OBJECTIVES:

To practice the complete sequence under different conditions.

- Run teams of four, in different lanes (inside/outside), with and without opponents, with and without handicap.
- Use shorter distances i.e. 4x50 m or 4x75 m.

#### TIPS:

- Focus your concentration.
- Sprint maximally into the exchange.
- Accelerate maximally away from the incoming athlete.



# SPRINT HURDLES





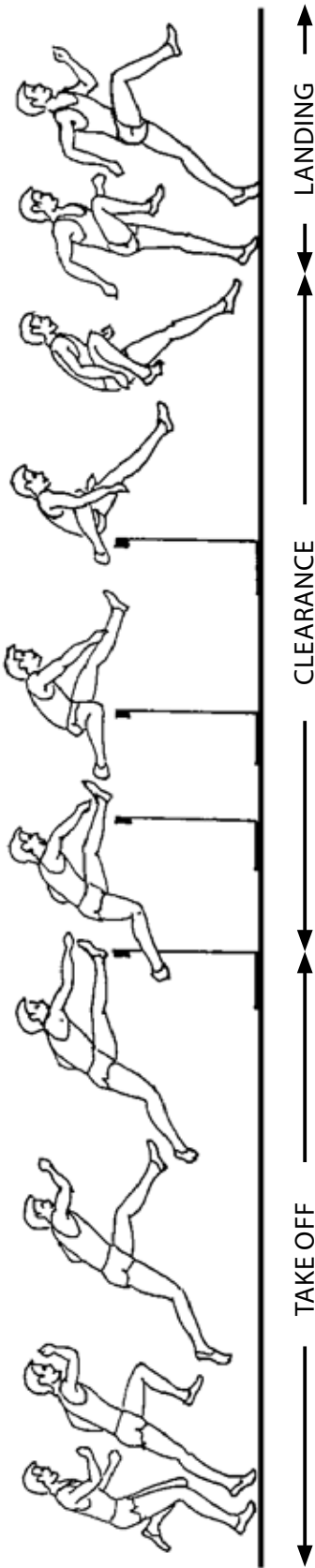

## Sprint Hurdles – Whole Sequence

### Phase Description

Sprint hurdling comprises two elements: **SPRINTING** between the hurdles and **HURDLE CLEARANCE** (which can be broken down into take off, clearance and landing phases).

- In the sprinting element the hurdler focuses on repeated three stride accelerations.
- In the hurdle clearance element the hurdler minimises the time in the air and prepares for the next running stride.

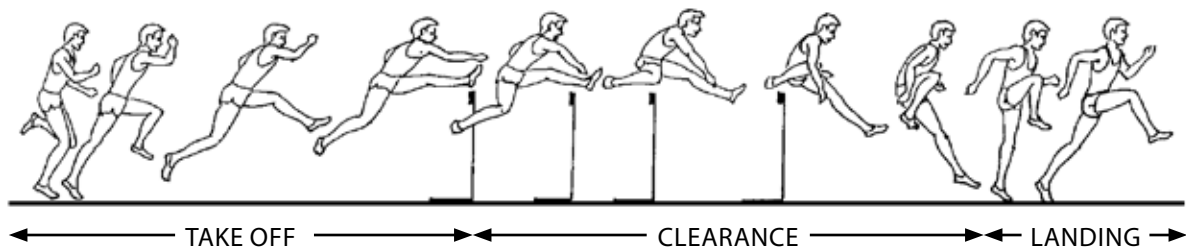

## APPROACH / 3-STRIDE RHYTHM

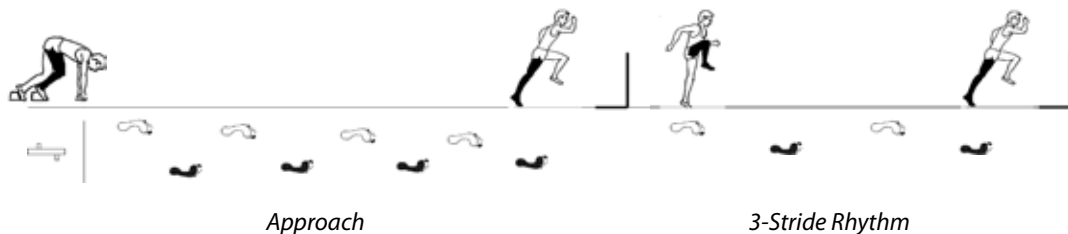

### Objective

To maximise acceleration to the first hurdle and speed between the hurdles.

### Technical characteristics

- Usually eight strides to the first hurdle (take off leg is in the front position in the starting blocks).
- Upright body position is achieved earlier than in a sprint start.
- Three strides between the hurdles (short-long-short).
- High body position between the hurdles.

#### HELP ATHLETES TO:

- Determine optimum number of strides for approach to first hurdle.
- Accelerate with head in natural alignment and not suddenly look up for the first hurdle.
- Sprint and hurdle strongly but relaxed, with a forward visual focus.
- Develop consistency and confidence in the approach to the first hurdle.
- Feel rhythm between the hurdles.

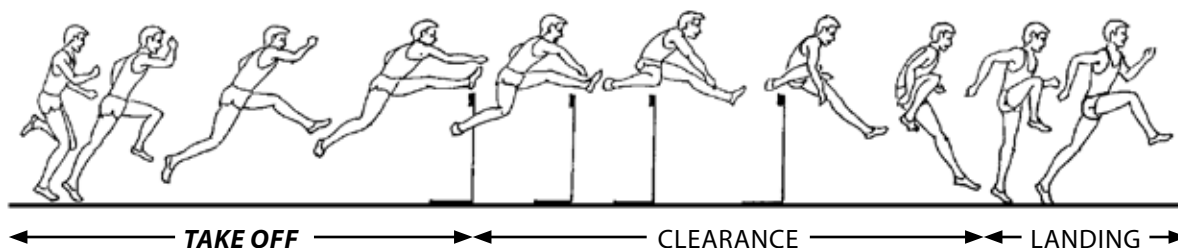

## TAKE OFF PHASE

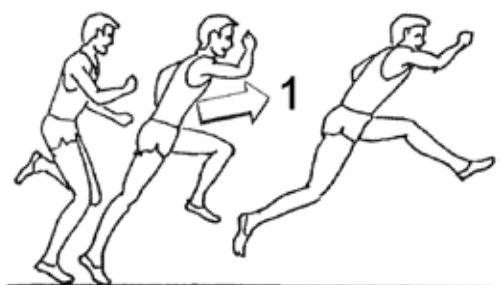

### Objective

To establish a trajectory which minimises the height over the hurdle.

### Technical characteristics

- High body position for the attack.
- Drive is more forward than upward. (Run 'into' the hurdle, do not jump) (1)
- Hip, knee and ankle joints of the support leg are fully extended.
- Thigh of the lead leg swings rapidly to the horizontal position.

#### COACHES SHOULD:

- Observe from the front and side.
- Ensure that the visual focus is maintained forwards.
- Observe the speed and extension of the ankle, knee and hip joints of take off leg.
- Observe the position and action of the lead leg.

#### HELP ATHLETES TO:

- Run fast and 'tall' and 'attack' the hurdle.
- Drive the free leg quickly through to the horizontal position and claw down.
- Focus visually down the track, not at the hurdle.

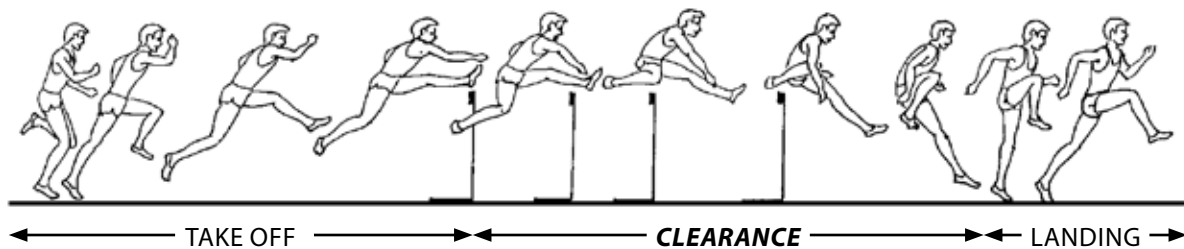

## CLEARANCE PHASE

### *General*



←  $\frac{2}{3}$  → ←  $\frac{1}{3}$  →



←  $\frac{2}{3}$  → ←  $\frac{1}{3}$  →

## Objective

To minimise the loss of speed and time in the air.

## Technical characteristics

- Take off is well in front of the hurdle from the ball of the foot (two thirds of the overall hurdle stride).
- Lead leg is actively lowered as quickly as possible after the hurdle.
- Landing is active and on the ball of the foot (no heel contact at touchdown).

### COACHES SHOULD:

- Observe the action of the limbs and position of the trunk over the hurdle.
- Ensure that the athlete optimises the modification of the sprint action.
- Observe the take off and landing points.



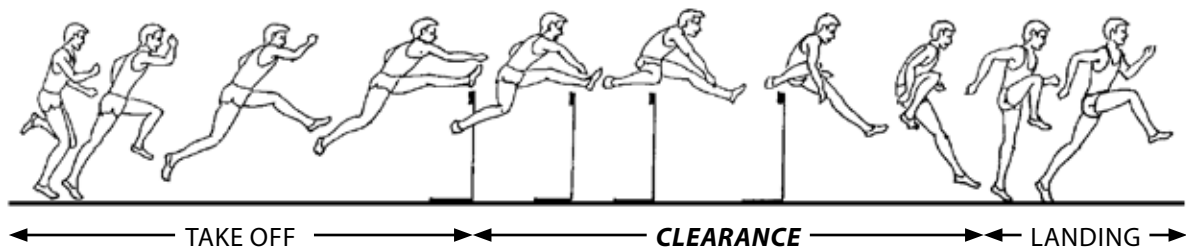

## CLEARANCE PHASE

### *Lead Leg*

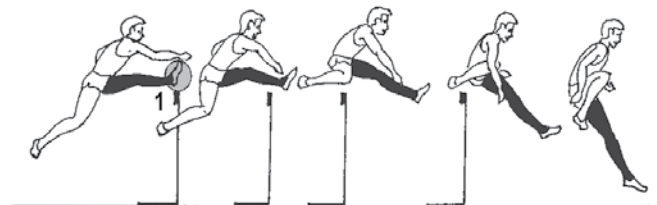
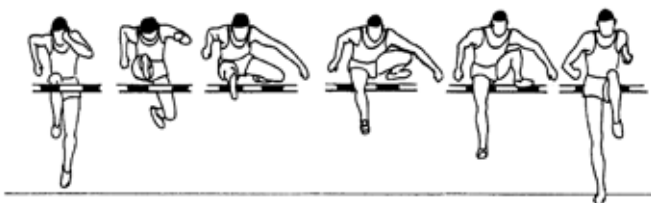
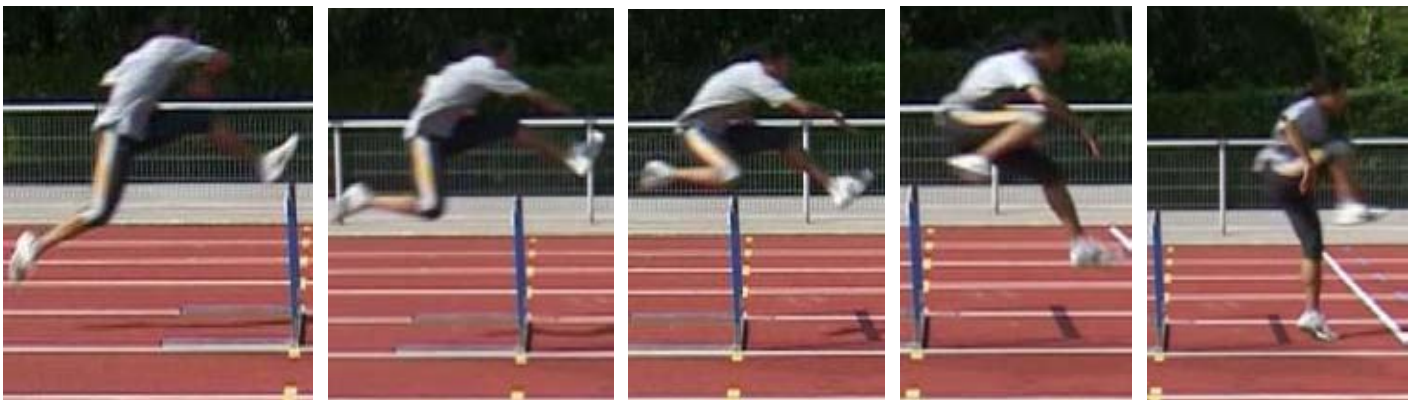

## Objective

To optimise forward lean and to minimise time over the hurdle.

## Technical characteristics

- Lower part of the lead leg is actively extended forwards and then downwards in the direction of running.
- Foot of the lead leg is flexed. (1)
- The lean forward of the trunk is more pronounced for 'higher' (relative to athlete's height) hurdles, and only what is necessary for 'lower' hurdles.
- Shoulders remain parallel to the hurdle and facing forwards.

### COACHES SHOULD:

- Observe that the athlete's acceleration and sprinting is optimal.
- Observe the overall rhythm of the action.
- Ensure that there is no slowing down off the hurdle.

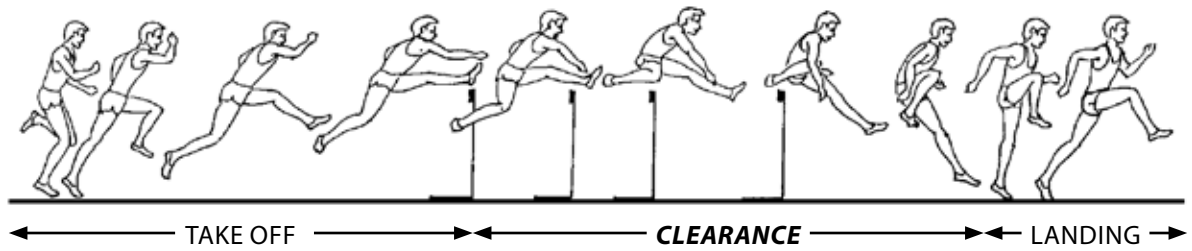

## CLEARANCE PHASE

### *Trail Leg*

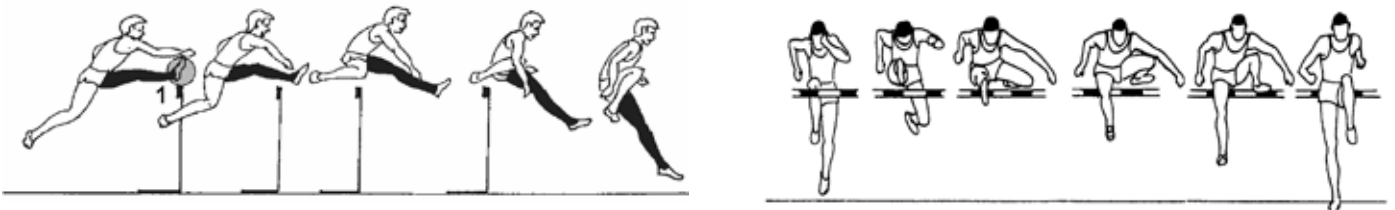

## Objective

To minimise the height over the hurdle and to prepare for an active landing.

## Technical characteristics

- Trail leg is drawn alongside the body.
- Thigh of the trail leg is roughly parallel to the ground at clearance. Angle between the thigh and lower leg is about 90° or less.
- Ankle of the trail leg is dorsiflexed markedly. Toe is tilted upward. (1)
- Knee of the trail leg is kept high as it pulls through. (2)

### HELP ATHLETES TO:

- Develop the flexibility to perform the actions.
- Maintain actions, and not 'float' over the hurdle.
- Keep lead leg in line with sprinting.
- Keep heel of trail leg close to buttock and then pull knee through in a high position and fully to the line of sprinting.

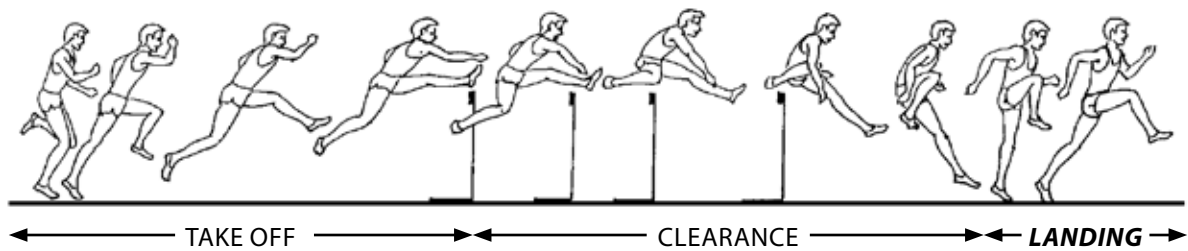

## LANDING PHASE



### COACHES SHOULD:

- Observe the position of the hips relative to the touchdown foot.
- Adjust hurdle height and spacing in training to optimise learning.
- Observe the action of the trail leg and transition to sprinting between the hurdles.

## Objective

To make a fast transition to running.

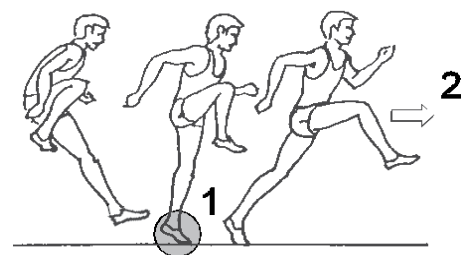

## Technical characteristics

- Landing leg is 'stiff'. Landing is on the ball of the foot. (1)
- Body should not lean backwards on landing.
- Trail leg stays tucked until touchdown then it pulls quickly and actively forwards. (2)
- Contact with the ground is brief, the first stride is aggressive.

### HELP ATHLETES TO:

- Accelerate 'off' the hurdle.
- 'Snap' the trail leg through to assist the transition to sprinting and acceleration into the next stride.
- Develop the power endurance to maintain the rhythmical sprinting through 10 hurdles.

## STEP 1 RHYTHMIC RUNS

### OBJECTIVES:

To introduce the rhythm of the sprint hurdles.

#### TIPS:

- Sprint naturally without jumping over the canes.
- Feel the 3-stride rhythm.
- Adjust position of canes as needed. Adapt the equipment to the athlete, not the other way around.

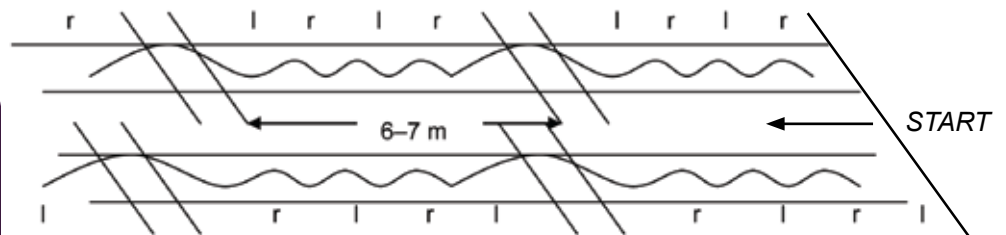

- Use sticks to mark 0.5-1 m spaces 6-7 m apart.
- Use a short approach with either leg to take off.
- Run over the sticks with 3 strides in between.
- Do not jump.
- Distance between canes increases with speed.

## STEP 2 RHYTHMIC RUNS OVER OBSTACLES

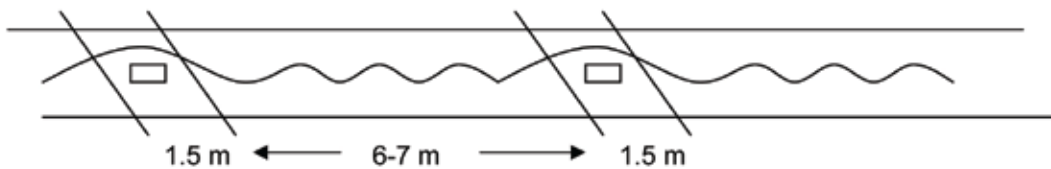

### OBJECTIVES:

To clear obstacles using the rhythm of the sprint hurdles.

- Mark 1.5 m spaces 6-7 m apart.
- Place small obstacles (i.e. boxes, balls) in the spaces.
- Run over the spaces with 3 strides in between.

#### TIPS:

- Sprint naturally, look ahead and don't jump over the obstacles.
- Feel the 3-stride rhythm.
- Adjust position of obstacles as needed.

## STEP 3 RUNS ALONGSIDE THE HURDLE

### OBJECTIVES:

To introduce lead and trail leg clearance of hurdles.

#### TIPS:

- Emphasise rhythm rather than 'reaching for the hurdles'
- Height of hurdles should be suitable.
- Lead leg landing should be 'stiff' and active - not soft or rigid.



- Use hurdles of moderate height 7-8 m apart.
- Run alongside hurdles in 3-stride rhythm.
- Clear the hurdle with either lead or trail leg.

## STEP 4 TRAIL LEG DRILLS



### OBJECTIVES:

To improve trail leg action.

- Start with exercises standing upright.
- Add hurdles to get correct height.
- Proceed to walking and jogging.

### TIPS:

- For trail leg drill, ensure landing foot is beyond the hurdle.
- Increase speed as confidence grows.
- Don't exaggerate the lean into the hurdle.

## STEP 5 LEAD AND TRAIL LEG RUNS

### OBJECTIVES:

To practise lead and trail leg action together.



### TIPS:

- Initially, don't rush the action.
- Trail leg knee is pulled through high to the front
- Let the action develop naturally.

- Place obstacles or hurdles 7-8.5 m apart.
- Use different heights for lead and trail legs.
- Clear with either lead or trail leg.

## STEP 6 WHOLE SEQUENCE



### OBJECTIVES:

To link the whole sequence of sprint hurdling.

- Place obstacles or hurdles 7-8.5 m apart.
- Use different heights for lead and trail legs.
- Clear with either lead or trail leg.

### TIPS:

- Rhythmically sprint over the hurdles, don't jump.
- Focus ahead and don't look for the hurdles.
- Accelerate off the hurdles.



# STEEPLECHASE







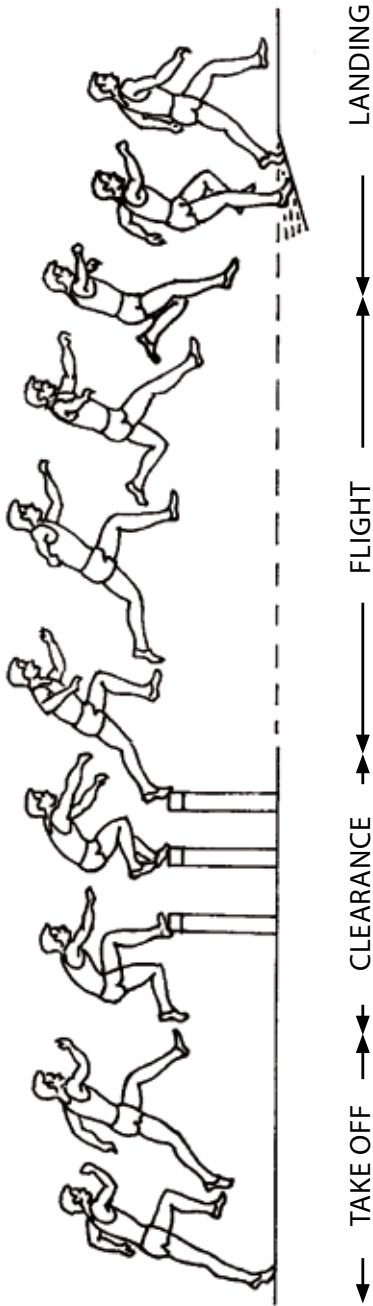

## Steeple Chase – Water Jump

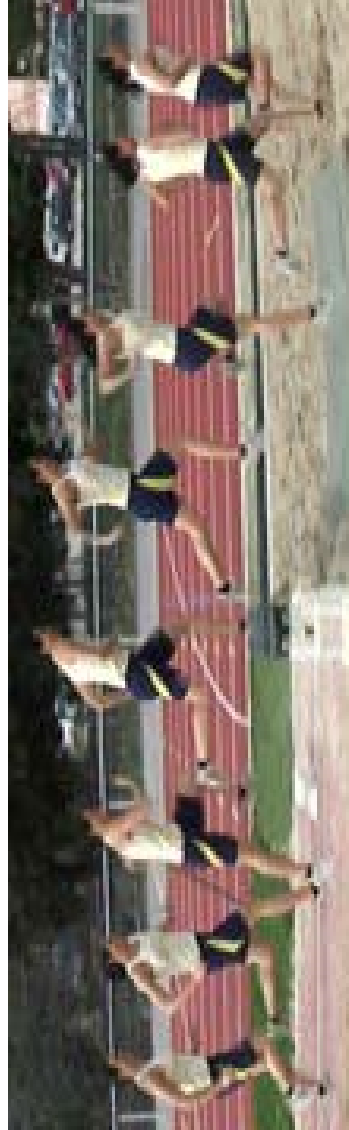

### Phase Description

The steeplechase comprises three elements: RUNNING between the barriers, BARRIER CLEARANCE (which can be broken down into take off, clearance and landing phases) and WATER JUMP CLEARANCE (which can be broken down into take off, clearance, flight and landing phases).

- In the Running between the barriers element the runner covers the distance using technique and tactics similar to other middle and long distance races.
- In the barrier and water jump clearance phases the runner minimises time in the air and disturbance to the running action.
- In the barrier and water jump clearance elements the runner minimises time in the air and the disturbance to the running action.
- In the barrier and water jump clearance elements the runner minimises time in the air and the disturbance to the running action.
- In the barrier and water jump clearance elements the runner minimises time in the air and the disturbance to the running action.

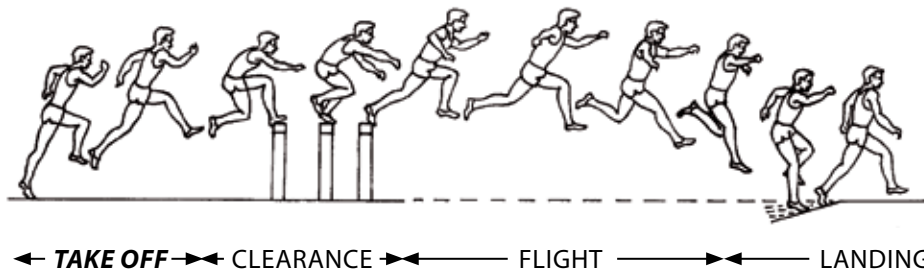

## WATER JUMP CLEARANCE

### *Take Off Phase*



#### COACHES SHOULD:

- Observe that the athlete does not take off too close, too far, too high an angle or too flat an angle from the barrier.
- Observe that the drive leg is actively extended.
- Ensure the thigh of the lead leg swings through to the horizontal position.

### Objective

To make a smooth transition from running to clearance with minimum loss of speed.

### Technical characteristics

- Take off angle is relatively flat.
- Hip, knee and ankle joints of the support leg are fully extended.
- Thigh of the lead leg swings quickly to the horizontal position.

#### HELP ATHLETES TO:

- Focus ahead and not look down at the barrier.
- Take off on either foot.
- Adapt to having other athletes around them during the approach and take off.

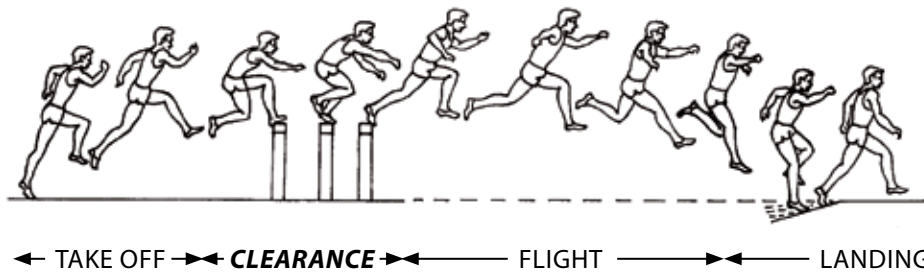

## WATER JUMP CLEARANCE

### *Clearance Phase*

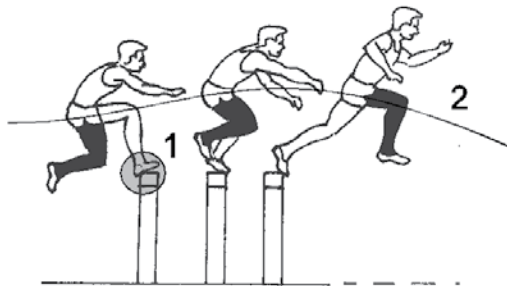

#### COACHES SHOULD:

- Observe the path of the athlete over the barrier.
- Observe the foot contact and push off if athlete steps on the barrier.
- Ensure that the athlete does not 'hook' the lead leg if hurdling the barrier.

## Objective

To minimise the time over the barrier.

## Technical characteristics

- Athlete either steps on barrier or hurdles the barrier
- Support leg is well bent.
- Trunk leans forwards.
- Touchdown on the barrier is with the middle of the foot. (1)
- Hurdling requires speed to be maintained
- Centre of mass stays low throughout. (2)

#### HELP ATHLETES TO:

- Gain confidence.
- 'Flow' over the barrier rather than standing on top or jumping over.
- Concentrate over the barrier in the company of other athletes.

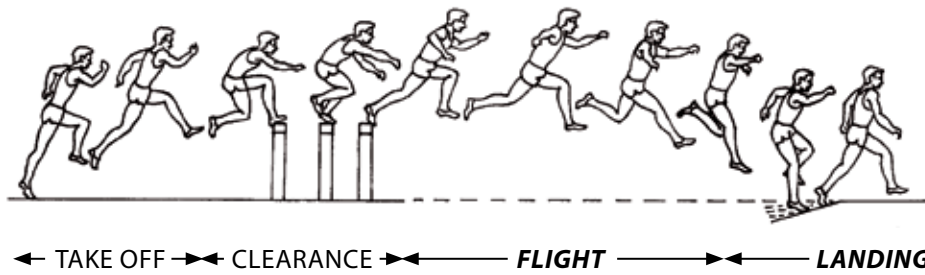

## WATER JUMP CLEARANCE

### *Flight and Landing Phases*

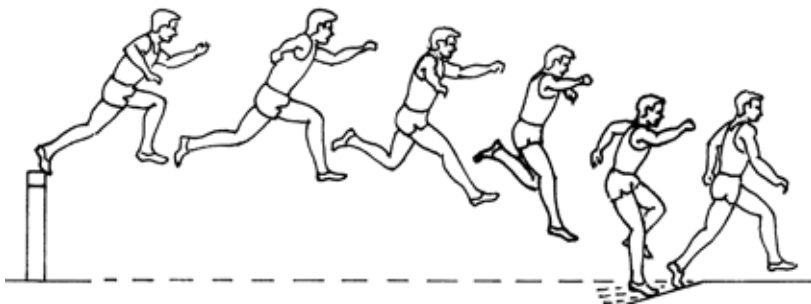

#### COACHES SHOULD:

- Ensure that the arm action provides balance and coordination.
- Observe the athlete does not brake or collapse on landing.
- Observe the trail leg moving quickly through and in the running line.
- Ensure the running rhythm is quickly re-established.

## Objective

To make a long, flat jump and an immediate transition to running.

## Technical characteristics

- Push-off from the barrier is forward and downward.
- Arms provide balance during the flight.
- Trunk leans forwards.
- Support leg is almost fully extended for the touchdown.
- Free leg drives ahead quickly after landing.

#### HELP ATHLETES TO:

- Hold the correct position for the appropriate time.
- To swing out and across the water, rather than up and over.
- Actively control the landing to ease the transition to running.
- Regain race rhythm.

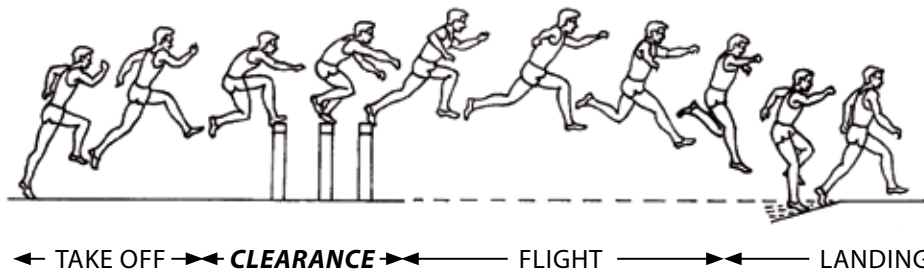

## BARRIER CLEARANCE

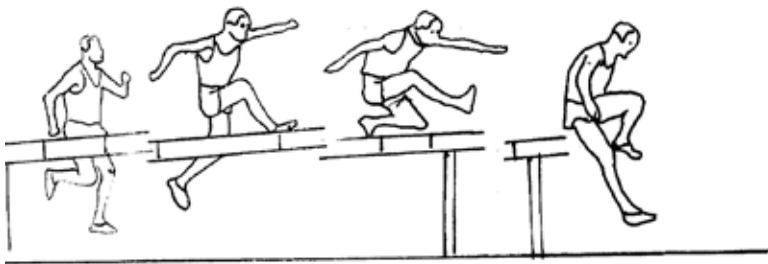

### COACHES SHOULD:

- Ensure that the athlete does not 'hook' the lead leg when hurdling.
- Observe the athlete does not brake or collapse on landing.
- Ensure the running rhythm is re-established.

## Objective

To minimise the time in the air and the loss of speed.

## Technical characteristics

- Take off is well in front of the barrier, the distance dependent on the speed.
- Clearance is low.
- Lead leg is actively lowered after clearance.
- Transition to the running stride is quick - running rhythm is maintained.

### HELP ATHLETES TO:

- 'Flow' over the barrier.
- Concentrate over the barrier in the company of other athletes.
- Actively control the landing to ease the transition to running.
- Regain race rhythm.

## STEP 1 HIT THE SPOT

### OBJECTIVES:

To learn how to adjust the stride to clear barriers.

#### TIPS:

- Feel equally 'natural' with either lead leg.
- Look ahead and adjust for obstacles as early and smoothly as possible.
- Adapt to running among others.

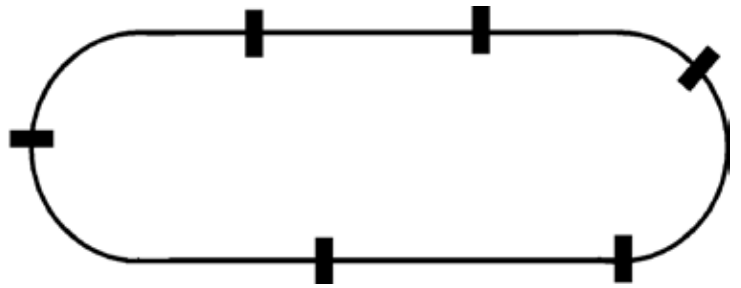

- Mark a circular course and place low obstacles (boxes) at uneven distances.
- Run around the course.
- Adapt the stride length and frequency to clear each obstacle.
- Maintain the running rhythm

## STEP 2 STEP TECHNIQUE I

### OBJECTIVES:

To introduce basic barrier technique/maintain rhythm before and after.

#### TIPS:

- Use boxes or a lower barrier to develop confidence.
- Avoid 'standing up' on the barrier.
- Wear spiked shoes for safety.



- Clear a barrier with a step technique with minimum 30m approach run and 30m run out.
- Use a box or boxes for take off according to the stage of learning of the athlete.
- Do not mark starting spot (so strides must be adjusted each time).

## STEP 3 STEP TECHNIQUE II

### OBJECTIVES:

To master basic barrier technique.



- Clear 2-3 barriers with step technique with minimum 30m approach run and 30m run out.
- Increase approach speed to race rhythm.
- Vary take off leg

#### TIPS:

- 'See' the barrier early and adjust stride.
- Keep low and 'flow' over the barrier.
- Maintain running rhythm.

## STEP 4 HURDLE TECHNIQUE

### OBJECTIVES:

To learn the hurdle technique of barrier clearance/maintain rhythm.

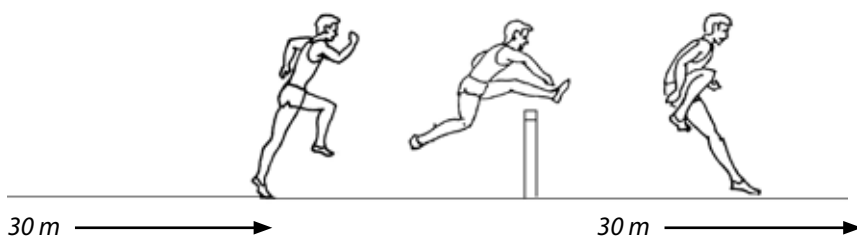

- Hurdle a sequence of 2-3 barriers.
- Vary take off leg.
- Increase approach speed to race rhythm before and after the barrier.

### TIPS:

- 'See' the barrier early and adjust stride.
- Keep low and 'flow' over the barrier.
- Adapt to presence of other athletes.

## STEP 5 WATER JUMP TECHNIQUE OVER BARRIER

### OBJECTIVES:

To introduce the water jump technique.

### TIPS:

- Look ahead and keep low over the barrier.
- Drive off the barrier and hold the position in the air for a moment.
- Land controlled and run out of sand.

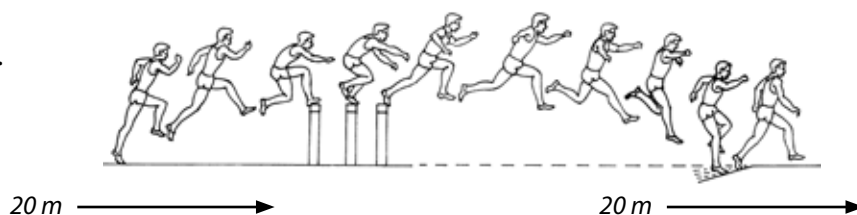

- Clear a barrier as in water jump off a 20 m approach run and land in a sand pit.
- Maintain rhythm over the barrier and run out of the sand.
- Check for distance in the landing.
- Add other athletes.

## STEP 6 WATER JUMP –WHOLE SEQUENCE

### OBJECTIVES:

To master the water jump technique.

### TIPS:

- Wear spiked shoes for safety.
- Drive in a balanced position out and over the water.
- Land controlled and quickly regain running rhythm.



- Clear water jump off a 30 m approach run and 30 m run out of the pit.
- Do not mark the starting spot (so strides must be adjusted each time).
- Maintain rhythm
- Add other athletes.





# RACE WALKS

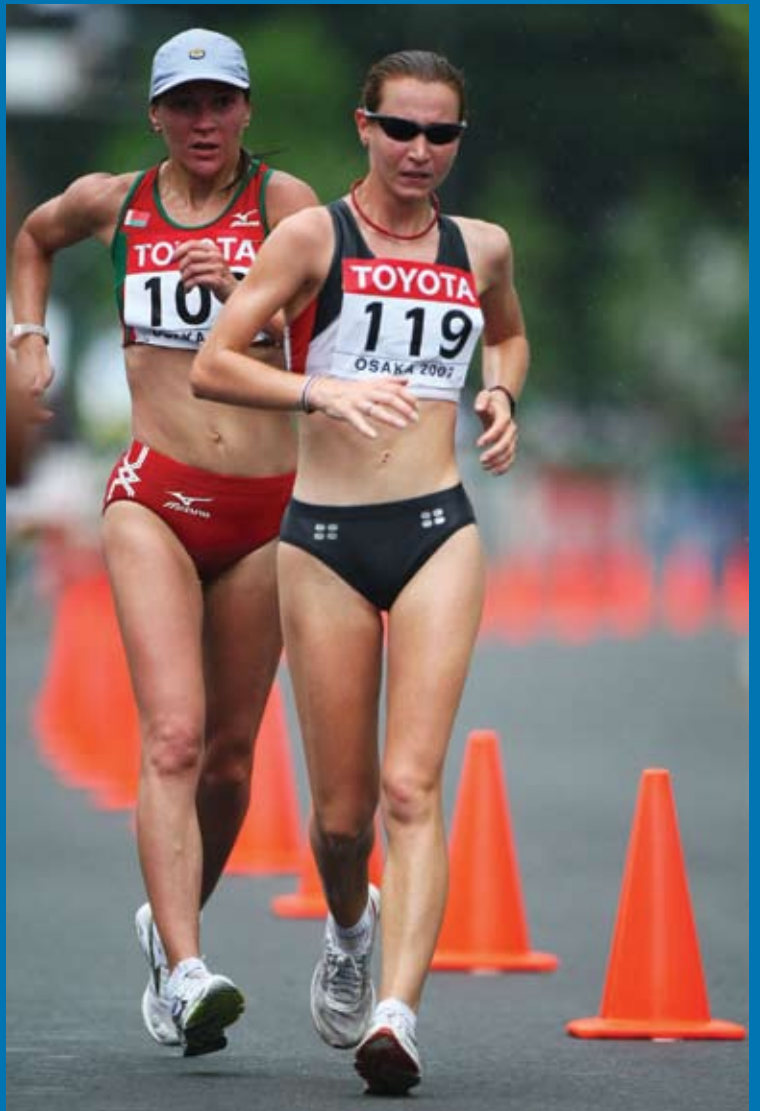



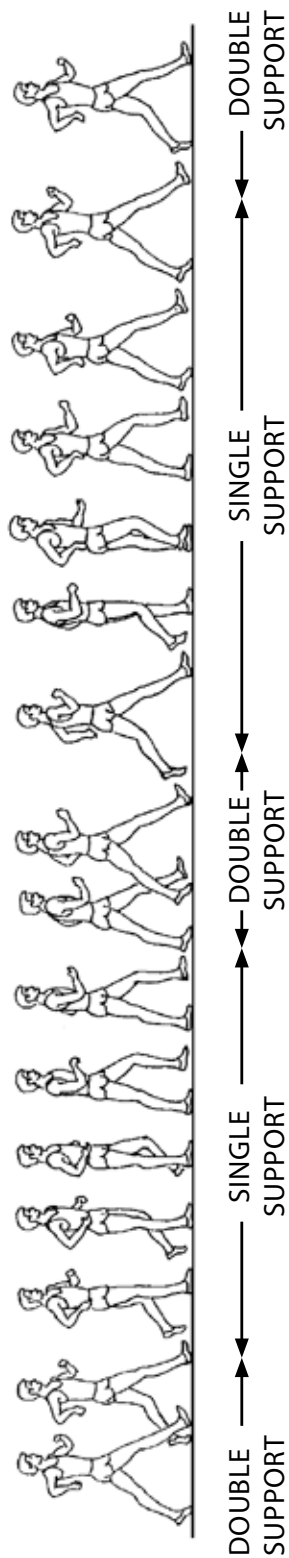

# RACE WALKING – Whole Sequence

## Phase Description

Each Race Walking stride comprises a SINGLE SUPPORT PHASE (which can be divided into front support and rear support phases) and a DOUBLE SUPPORT PHASE.

- The single support phase provides acceleration and includes preparation for planting the foot of the free leg.
- The double support phase is necessary in order to maintain ground contact at all times.



Definition of Race Walking: "Race Walking is a progression of steps so taken that the walker makes contact with the ground, so that no visible (to the human eye) loss of contact occurs."

Two basic rules therefore define Race Walking:

1. One foot must be on the ground at all times, the front foot must make contact before the rear foot leaves the ground.
2. The support leg must be straightened (i.e. not bent at the knee) from the moment of first contact with the ground until the vertical upright position.

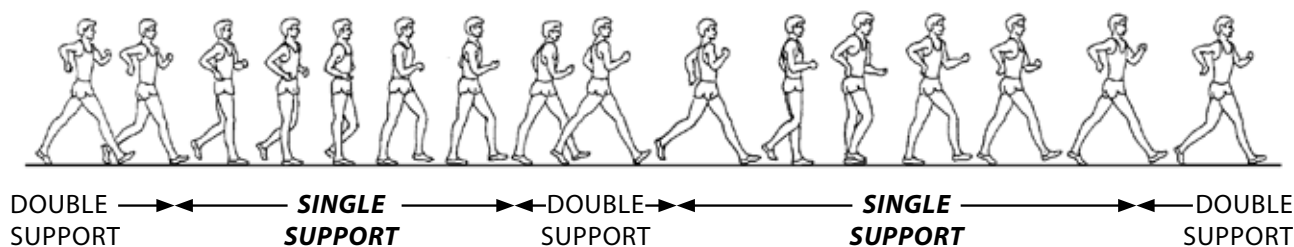

## SINGLE SUPPORT PHASE

### *Rear Support*



#### COACHES SHOULD:

- Observe that the support leg is extended at hip, knee and ankle and foot drives off the forefoot.
- Observe hip and shoulder actions from front and side.

## Objective

To provide acceleration and to prepare for the double support phase.

## Technical characteristics

- Support leg is straight.
- Support leg remains extended as long as possible.
- Foot of the support leg points straight ahead and rolls along the outside edge of the sole up to the tip of the toes.
- Free leg passes the support leg with the knee and the lower leg kept low.
- Front foot is planted on the heel.

#### HELP ATHLETES TO:

- Maintain continuous contact.
- Coordinate and relax the actions of the hip and shoulder.
- Focus on the maintenance of rhythm throughout all phases.

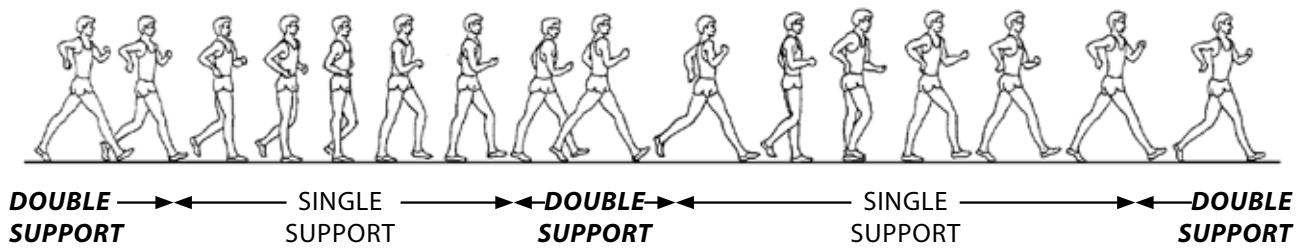

## DOUBLE SUPPORT PHASE

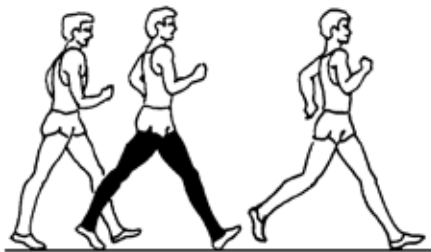

### COACHES SHOULD:

- Observe that continuous contact is maintained and that both knees are extended.
- From the front or rear, observe that feet are placed in an almost straight line.
- Observe from different angles the head position and visual focus.

## Objective

To link the rear and front support phases.

## Technical characteristics

- Front foot lands smoothly on the heel while the rear foot is in a heel-up position.
- Both knees are extended.
- Arms swing alternately.

### HELP ATHLETES TO:

- Maintain continuous contact.
- Synchronise the arms in a relaxed drive back.
- Focus visual attention ahead to maintain head alignment through all phases.

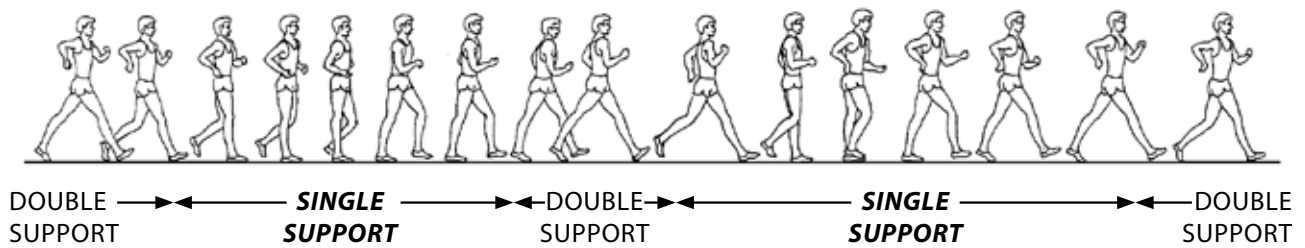

## SINGLE SUPPORT PHASE

### *Front Support*

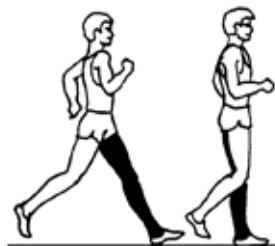

#### COACHES SHOULD:

- Observe that athlete's foot contacts the ground ahead of the body and the leg is not rigid or 'braking'.
- Observe the height of recovery of the knee and heel of free leg.
- Observe arm action from front and side and overall rhythm of the action.

### Objective

To minimise the braking forces.

### Technical characteristics

- Foot placement of the front leg is active with a backward sweeping motion.
- Deceleration phase is as short as possible.
- Knee of the front leg must be extended.
- Swinging leg passes the support leg with the knee and the lower leg kept low.

#### HELP ATHLETES TO:

- Maintain continuous contact.
- Utilise an 'active clawing' action at each footstrike to minimise deceleration.
- Keep shoulders relaxed and square to the front.

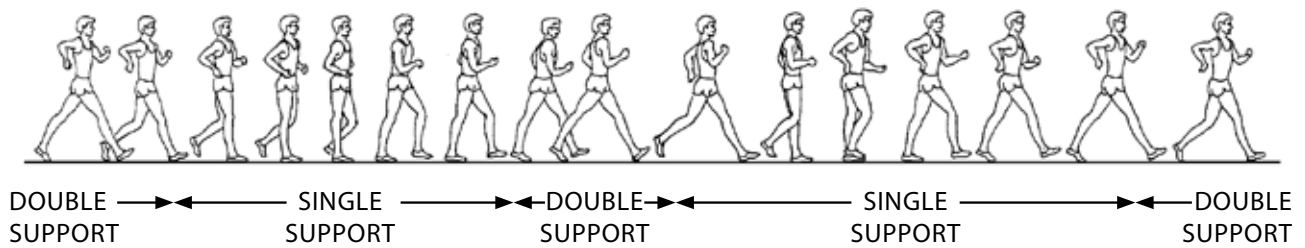

## FOOT PLACEMENT

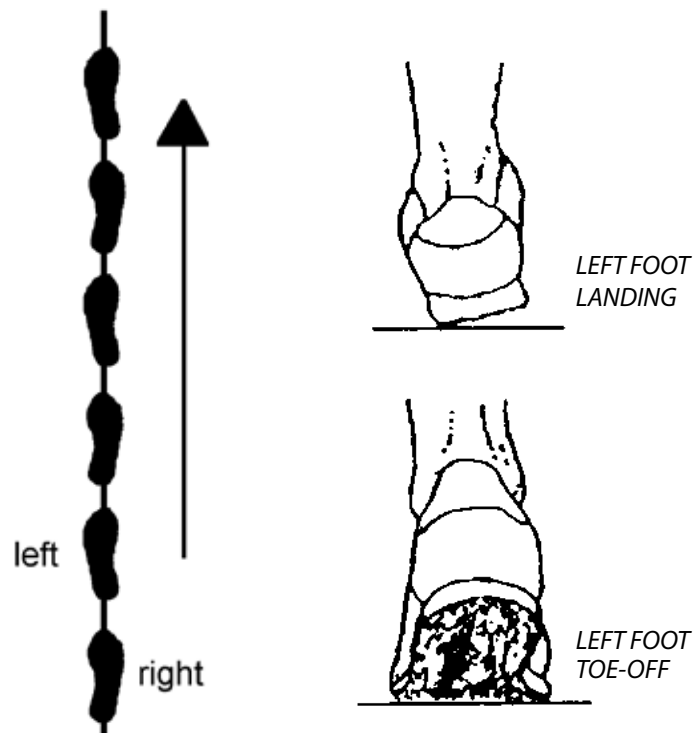

### Objective

To place feet correctly for achieving optimum stride length.

### Technical characteristics

- Feet are placed in a straight line with the toes pointing straight ahead.
- Touchdown is on the heel and is followed by a rolling movement along outside of sole up to the ball of the foot.
- Push-off is from the ball of the foot and is followed by a rolling off the tip of the big toe.

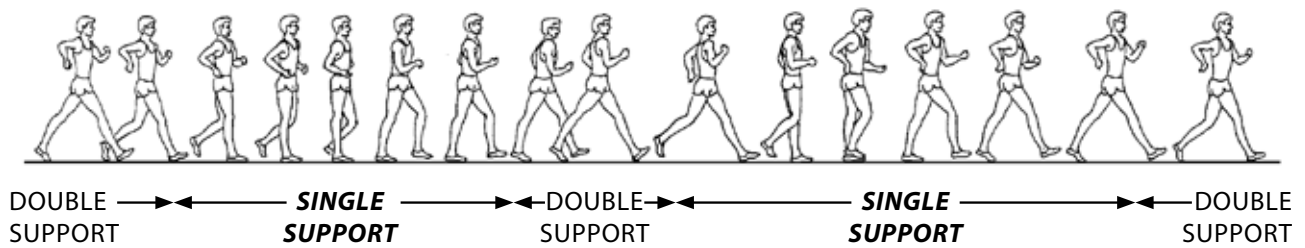

## HIP MOVEMENT

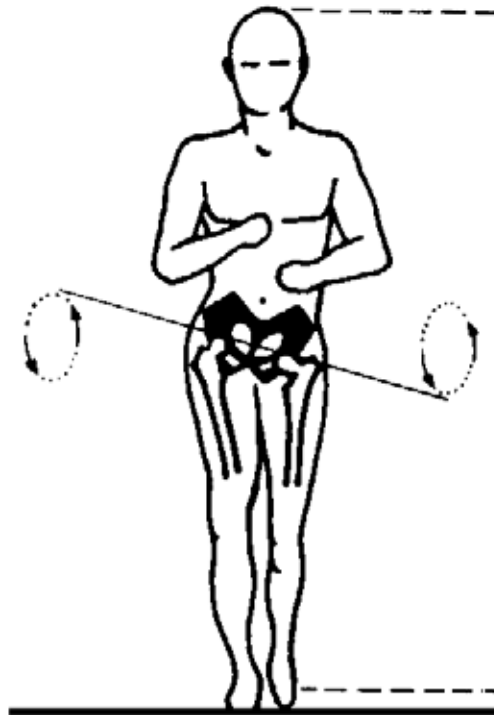

*Head should remain on same level*

### Objective

To rotate the hips in a manner which ensures proper foot placement and optimum stride length.

### Technical characteristics

- Lateral movement of the hips is visible but should not be exaggerated.
- Hip flexibility is essential.



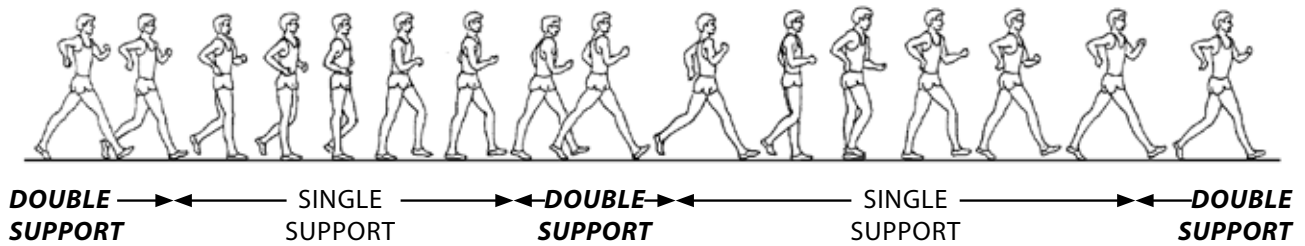

## ARM MOVEMENT



### COACHES SHOULD:

- Observe arm action from front and side.
- Ensure that practices keep arm action to chest height at the front and no higher.
- Observe the overall rhythm of the action.

### HELP ATHLETES TO:

- Keep shoulders relaxed and square to the front.
- Hands - 'chest to pocket' for the arm action.
- Think about quick, relaxed backward drive of the upper arms - "back, back".

## Objective

To conserve forward momentum and balance.

## Technical characteristics

- Upper body should remain relaxed.
- Shoulder drops to counterbalance the drop of the opposite hip.
- Elbows are carried at approx. 90° angle and kept close to the body.
- Hands should not move lower than waist level or higher than mid chest height.

## STEP 1 NATURAL WALKING

### OBJECTIVES:

To introduce the power walking movement.

- Introduce the rules and a rough technical model.
- Walk with gradually increasing tempo, do not break into a run.
- Stride out comfortably and walk tall with a smooth rhythm for at least 100m.

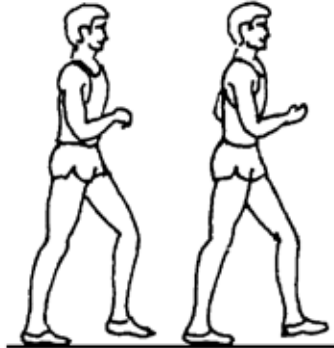

### TIPS:

- Imagine you are walking fast to an appointment.
- Look straight ahead
- Keep relaxed as tempo increases.

## STEP 2 RACE WALKING

### OBJECTIVES:

To develop strong rear foot push off and increase stride length.

### TIPS:

- Feel the push off and a long stride.
- Focus on the rhythm of the arms and legs working strongly together.
- Walk tall but relax the shoulders and hips.

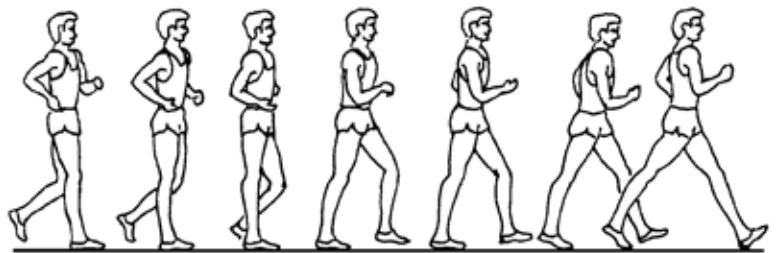

- As for Step 1 but push off harder from the rear foot
- Turn and stretch the hip and leg forwards on each stride.
- Maintain contact and straight knee, land with toes up.

## STEP 3 WALKING THE LINE

### OBJECTIVES:

To develop proper hip rotation.

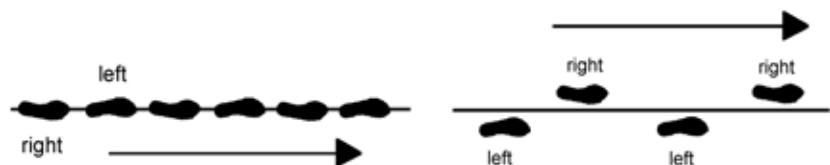

(1) Walk on the line

(2) Cross over the line

- As for Step 2 but walk along a line so that each footstep is on the line.
- Overstride and cross over the line (causes a shift of the weight to the supporting hip after loss of ground contact).

### TIPS:

- Focus concentration ahead and develop 'eyes in your feet'
- Have someone give feedback on your foot placement
- Do not progress to 'crossing over the line' until 'on the line' is achieved and comfortable
- Walk tall but relax the shoulders and hips.

## STEP 4 SPECIFIC MOBILITY EXERCISES

### OBJECTIVES:

To develop shoulder and hip flexibility.

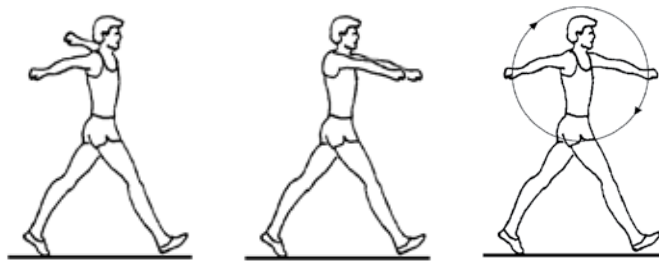

- Race walk at medium pace with arms out to the side, forward, in a “windmill” movement.
- Combine the exercises above, include crossing over the line.

### TIPS:

- Combine the exercises and change combinations to provide variety.
- Relax as arms pass through a dynamic range of motion.
- Maintain forward visual focus especially when combining with ‘line drill’.

## STEP 5 VARIED RHYTHM WALKING

### OBJECTIVES:

To adapt technique to various speed levels.

### TIPS:

- Try to change ‘gears’ while maintaining relaxation and technique.
- Progress to 400m plus with rhythm changes every 100m.
- Assess shin fatigue and limit any repetitions accordingly.

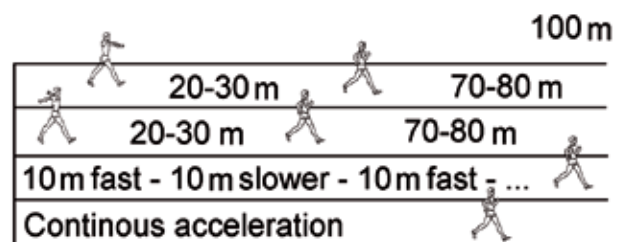

- Vary rhythm and pace over a distance of 100 m.
- Combine different arm positions (i.e. 20 m-30 m arms forward, then correct use of arms).
- Gradually increase the distance of varied rhythm.

## STEP 6 RACE WALKING OVER DISTANCE

### OBJECTIVES:

To maintain technique under conditions of fatigue.

### TIPS:

- Concentrate on correct technique, including frequency, rather than just speed.
- Assess shin fatigue and limit any repetitions accordingly.
- Use this as the beginning of training with repetitions and continuous walking.

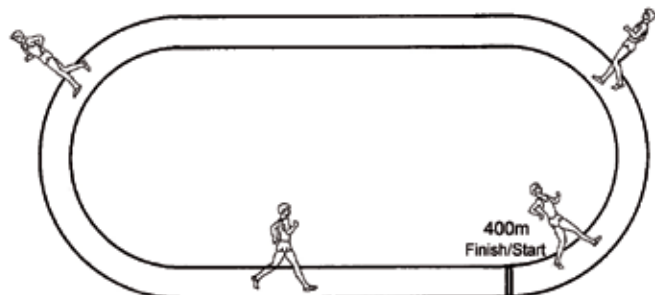

- Walk repetitions over at least 400 m.
- Concentrate on maintaining legal technique rather than speed.





**JUMP!**



# FUNDAMENTALS OF JUMPING

## 1. INTRODUCTION

At first look the four jumping events in athletics might appear very different from each other. From a technical point of view they range from the relatively simple Long Jump through the High Jump and Triple Jump to the apparently complex Pole Vault. There are, however, a number of very important commonalities among the jumps, the understanding of which will help the coach working with athletes in any of the events.

### **Aims**

The goal in the jumping events is to maximize either the measured distance or height of the athlete's jump. In the Triple Jump, of course, the goal is to maximize the distance of three consecutive jumps while in the Pole Vault the athlete is aided by the use of the pole.

### **Biomechanical Aspects**

Distance and height of flight are determined mainly by three parameters: (a) **velocity at take off**, (b) the **angle of take off** and (c) the **height of the centre of mass at take off**. Of these, take off velocity and take off angle are generally the most important.

The height of the centre of mass is determined by the athlete's body height though it is influenced by the athlete's position at take off. Take off velocity and take off angle are both the result of the actions of the athlete prior to and during take off. So, the take off is of major importance in all jumping events.

There are additional factors affecting the height of flight in the Pole Vault. The most important of these are the transfer of energy to the pole during the take off and then the return of that energy from the pole after the take off to provide additional lift to the athlete's body.

Once the flight path has been established at take off the measured result can be negatively influenced by, in the case of the High Jump and Pole Vault, ineffective bar clearance or, in the case of the Long and Triple Jump, poor landing technique.

### **Movement Structure**

The movements of the jumping events can be broken down into four main phases:

1. **Approach**
2. **Take off**
3. **Flight**
4. **Landing.**

In the Triple Jump the take off-flight-landing sequence is repeated three times. In the Pole Vault the four phases apply but the phase structure used by coaches is modified to take into account the additional movements the athlete makes because of the pole.

In the approach phase the athlete generates horizontal velocity. In the Long Jump, Triple Jump and Pole Vault of the final result is largely determined by the level of horizontal velocity at take off, therefore, the athlete's objective in the approach phase of these events is to come close to his/her maximum running speed. In the High Jump horizontal velocity plays a lesser part in the final result and the athlete's objective is to find the optimum rather than maximum running speed in the approach. The approach phase also includes preparation for the

take off. It is vital, therefore, that the running speed is appropriate for the athlete's ability to use it in the take off and that the athlete is in control of the speed.

**The characteristics of a good approach in all the events are:**

- It is fast.
- It is accurate and consistent.
- It prepares the athlete for a powerful take off.

In the take off phase the flight path of the athlete's body (and thus the maximum distance or height of flight) is determined. Clearly, the take off is of critical importance in all the jumping events. The athlete's objectives in this phase are to (a) ensure that his/her centre of mass is as high as possible at the moment of take off, (b) add the maximum level of vertical velocity to the horizontal velocity generated in the approach and (c) take off at the optimum angle. The optimums for (b) and (c) vary depending on the event and the technique used by the athlete.

**The characteristics of an effective take off are:**

- The athlete must be 'tall'.
- The take off foot is planted firmly in a fast, flat 'pawing' action – it is not stamped on the ground and there is no bracing action.
- The knee of the free leg is driven or punched through from the hips.
- The hip, knee and ankle joints are fully extended.

In the flight phase of the Long Jump and the three flight phases of the Triple Jump, the athlete's objectives are to avoid actions that would reduce the distance of the flight path and to position the body for landing. In the flight phase of High Jump and Pole Vault the athlete must avoid reducing the height of the flight path and ensure clearance of the bar. In the Pole Vault the objectives also include maximizing the additional lift available from the pole.

In the landing phase of the Long Jump and the final phase of the Triple Jump the athlete's objective is to minimise the loss of distance that occurs after the initial touchdown of the feet. In the first two landings of the Triple Jump the objective is to make the transition to an effective take off into the following phase. The athlete's objective in the landing phase of the High Jump and Pole Vault is land safely and avoid injury.

## 2. TEACHING JUMPING TECHNIQUE

Chaining and shaping methods are both used to teach the jumping events. Concentration should be on the following elements:

- Take off from a running approach
- Movements in the flight phase
- Landing

**Points to Emphasise:**

- Increased stride frequency at the end of the approach.
- Active foot plant with the entire sole at take off.
- Forceful lead leg action at take off.
- Full extension of the ankle, knee and hip joints at take off.



**Points to Avoid:**

- A decrease in speed at the end of the approach.
- Lowering of the centre of mass in preparation for take off.
- A bracing step with heel contact at take off.
- Standing jumps.
- Premature emphasis on the flight phase.

**Note:** Be aware that all jumping exercises involve a high mechanical load on the entire body, especially the foot, ankle and knee joints. Therefore take care to avoid overloading.

### 3. SKILL AND CONDITIONING EXERCISES

#### EXERCISE GROUP 1: GENERAL RUNNING EXERCISES AND DRILLS

All exercises and drills described in the Fundamentals of Running are valuable for jumpers.

#### EXERCISE GROUP 2: SPECIFIC RUNNING

- Acceleration Runs (all events) - imitation of the approach with or without imitation of take off.
- Runs with a pole (Pole Vault) – including Ankling, Heel Kick-up, High-knee and acceleration runs.
- Curved Runs (High Jump) – slalom runs and “J” runs (first part straight, second part curving to the left or right) with or without imitation of take off.

**Loading:**

Exercise	Distance	Repetitions	Sets	Load Level
Acceleration Runs	20-40 m	2-3	2-3	High
Runs with the Pole	20-40 m	3	2	Medium
Curved Runs	15-25 m	3-5	2	Medium

#### EXERCISE GROUP 3: BOUNDING (Take off and landing on alternate legs)

- Bounding from a standing start.
- Bounding from a short approach.
- Bounding from a fast approach.
- Bounding uphill.
- Bounding for distance (i.e. 5 x 10 bounds as far as possible).
- Bounding for speed (i.e. 5 x 30 m bounding - timed).

**Loading:**

Exercise	Distance	Repetitions	Sets	Load Level
Bounding from a standing start	20-50 m	3-5	2-4	Low
Bounding from a short approach	20-40 m	3-5	2-4	Medium
Bounding from a fast approach	15-30 m	2-4	1-3	High
Bounding Uphill	20-50 m	2-4	1-3	Low

## EXERCISE GROUP 4: HOPPING (Take off and landing with the same leg)

**Note:** Hopping produces a higher load than bounding. Always alternate left and right with each alternate repetition.

- Hopping from a standing start.
- Hopping from a short approach.
- Hopping from a fast approach.
- Hopping up stairs.
- Hopping for distance or time.
- Rhythmic hopping (i.e. l-l-l-r-r-r-l-l-l - etc. or l-l-l-r-r-l-l-r-r-l - etc.)

### Loading:

Exercise	Distance	Repetitions	Sets	Loading
Hopping from a standing start	10-15 m	2-4	2-4	Medium
Hopping from a short approach	10-20 m	2-4	2-4	Medium
Hopping from a fast approach	10-15 m	1-3	1-3	High
Rhythmic Hopping	15-30 m	2-4	2-4	Medium
Hopping up stairs	10-20 m	2-4	1-3	Medium

## EXERCISE GROUP 5: HURDLE JUMPS

Example: Single leg take off hurdle jump with one step in between and take off leg landing

- Ankle flips over mini hurdles
- Double leg hurdle jumps
- Single leg take off hurdle jumps with one step in between and lead leg landing
- Single leg take off hurdle jumps with three steps in between and lead leg landing
- Single leg take off hurdle jumps with one step in between and take off leg landing
- Single leg take off hurdle jumps with three steps in between and take off leg landing.

### Loading:

Exercise	Distance	Height	Number	Reps	Sets	Loading
Ankle flips	1.00-1.20 m	20-40 cm	5-10	3-5	3-6	Low
Double legged	1.40-1.80 m	60-90 cm	3-6	3-5	3-6	Medium
Single leg take off with lead leg landing	3-4 m (1 Step) 7-8 m (3 Steps)	40-60 cm	4-6	3-5	2-4	Medium
Single leg take off with take off leg landing	3-4 m (1 Step) 7-8 m (3 Steps)	50-90 cm	4-6	2-4	2-4	High

## 4. GAMES

### GAME 1

A variety of boxes and other objects are set up in a marked off area. The athletes move freely within the area jumping over each object as they come to it. The jumping movements can be varied (landing on the take off leg, swing leg or both legs).

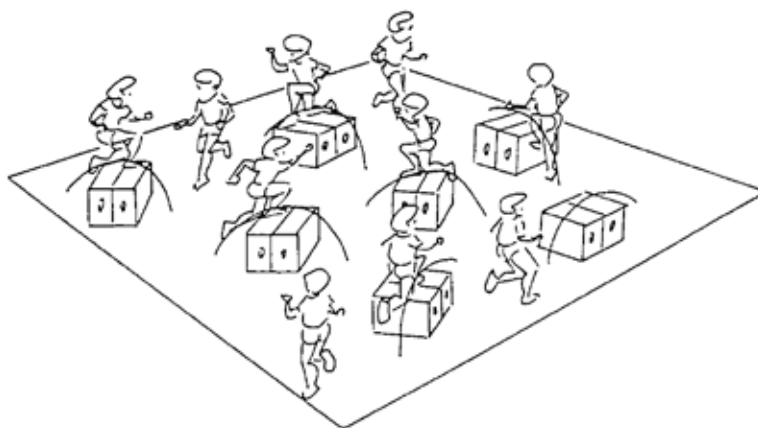

### GAME 2

An obstacle course is set up around a square area. A number of 'hunters' are designated. Their task is to 'capture' the other athletes. Captured athletes must run a lap of the obstacle course before being allowed back inside the square. The goal of the hunters is to get all the other athletes out of the square at the same time.

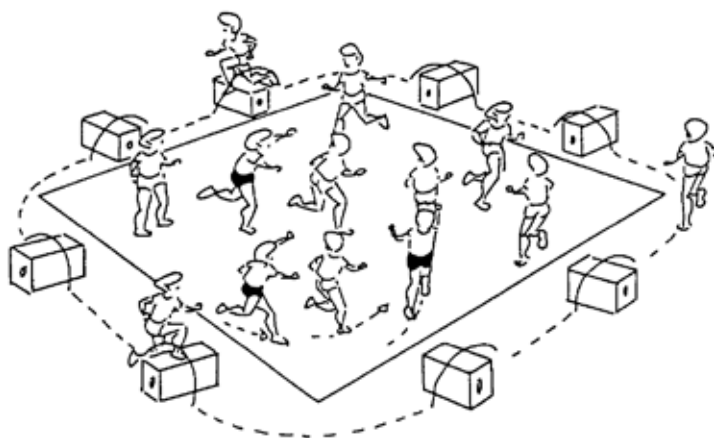

**Note:** The duration of this exhausting task must be limited to a number of 'rounds'. A new team of hunters is designated, for each new round.

### GAME 3

An obstacle course is set up for each team. The members of each team are split into two groups which are positioned at opposite ends of the course. The first runner completes the course and starts the second runner with a hand slap, etc. The race is over when all runners are back to their original position.

**Variation:** Running over obstacles in one direction and sprint on the flat in the opposite direction. Make the obstacles higher from jump to jump.

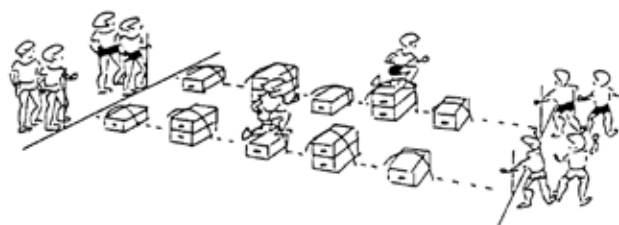

Over the obstacle course on the way there, flat run on the way back

## GAME 4

Two teams start at the opposite end of a double course. The teams try to catch up with each other. The race is won when a member of one team touches the back of a runner from the other team.

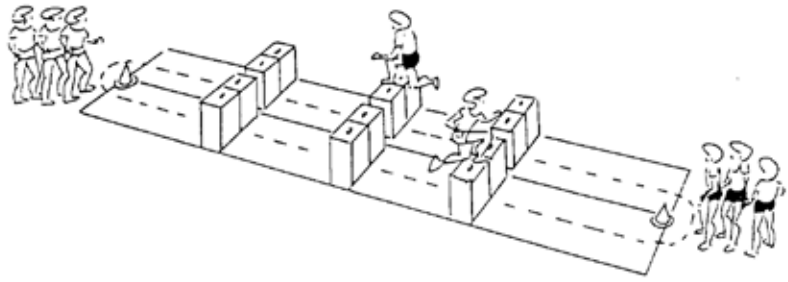

## 5. SAFETY AND ORGANISATION

- It is important to ensure that all approach areas are safe, particularly at take off points.
- Landing pits should be dug over before use and cleared of rocks and debris. They should also be dug over and raked at frequent intervals during use.
- Foam landing units should be thick and dense enough to prevent athletes 'bottoming out'. They should be fastened together securely to prevent athletes falling between two units.
- In those high jump and pole vault exercises where the athletes land on their feet, a well-dug sand pit is safe and acceptable.
- Only circular cross section bars should be used. Use ropes or rubber bands for beginners.
- When working with larger groups in the early stage of training sessions should be designed to maximise activity with several athletes being active at the same time. Long breaks are boring, particularly for youngsters.

# LONG JUMP





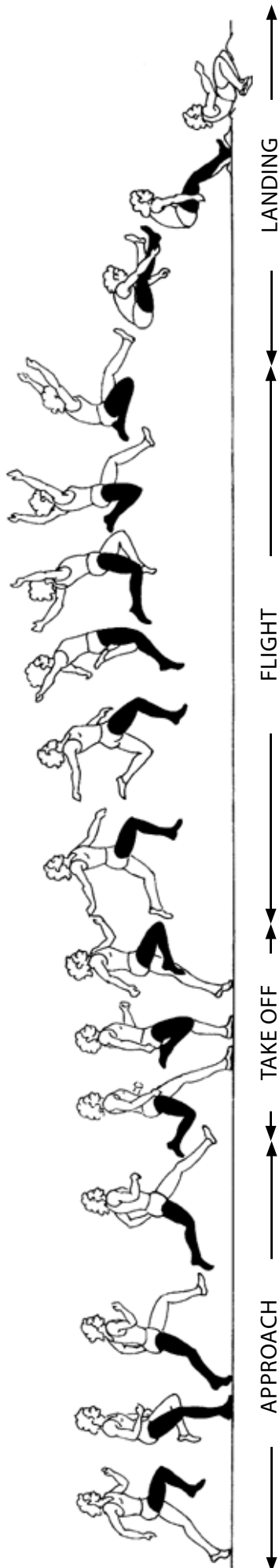

## Long Jump – Whole Sequence



### Phase Description

The long jump is divided into the following phases: APPROACH, TAKE OFF, FLIGHT and LANDING.

- In the approach phase the jumper accelerates to maximum controllable speed.
- In the take off phase the jumper generates vertical velocity and minimises the loss of horizontal velocity.
- In the flight phase the jumper prepares for landing. Three different techniques can be used: sail, hang and hitch-kick.
- In the landing phase the jumper maximises the potential distance of the flight path and minimises the loss of distance at the touchdown.

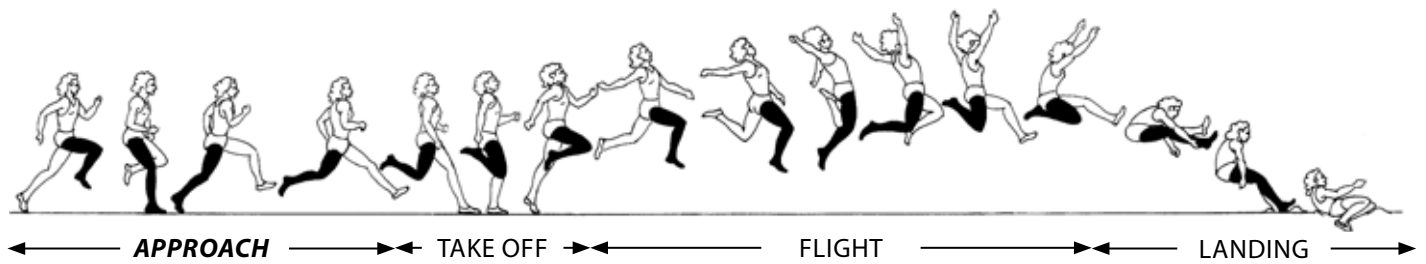

## APPROACH PHASE



### COACHES SHOULD:

- Observe that the athlete's acceleration and sprinting is optimal.
- Observe the overall rhythm of the action.
- Ensure that there is no slowing down.



### HELP ATHLETES TO:

- Sprint strongly but relaxed with a forward visual focus.
- Determine the optimum number of strides for their approach.
- Develop a feeling for consistency in both speed and length.

## Objective

To achieve maximum controllable speed.

## Technical characteristics

- Approach length varies between 10 strides (for beginners) and more than 20 strides (for experienced, elite jumpers).
- Running technique is similar to sprinting.
- Speed increases continuously until the take off board.



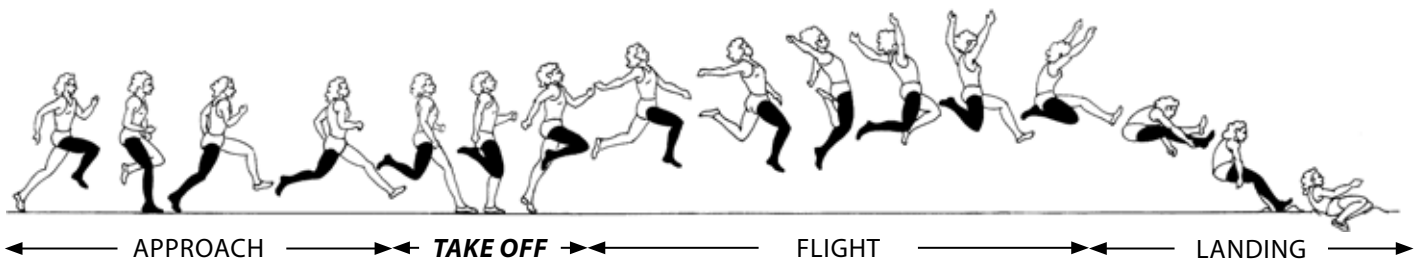

## TAKE OFF PHASE



### COACHES SHOULD:

- Observe from the front and side.
- Ensure that the visual focus is maintained forwards.
- Observe the speed and extension of the ankle, knee and hip joints.
- Observe the position of the free leg.

### HELP ATHLETES TO:

- Run fast and 'tall' off the board.
- Drive the free leg quickly through to the horizontal position and stop.
- Develop the strength so the take off leg does not collapse.



## Objective

To maximise vertical velocity and to minimise loss in horizontal velocity.

## Technical characteristics

- Foot plant is active and quick with a 'down and back' motion. (1)
- Take off time is minimised, minimum bending of the take off leg.
- Thigh of the free leg is driven to the horizontal position. (2)
- Ankle, knee and hip joints are fully extended.

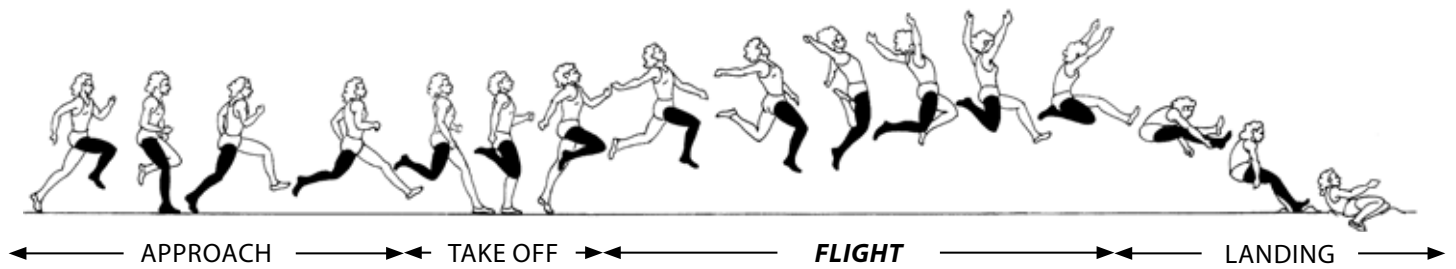

## FLIGHT PHASE

### *Sail Technique*

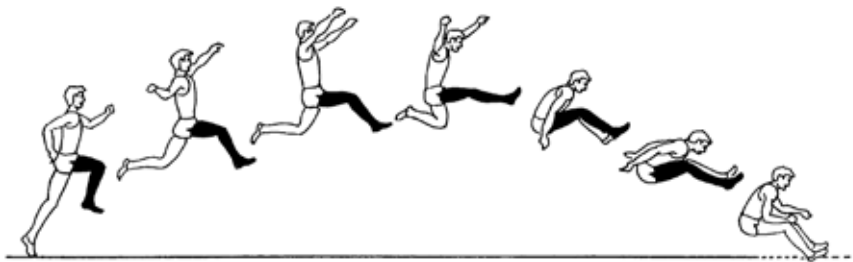

## Objective

To prepare for an efficient landing.

## Technical characteristics

- Free leg is held in the take off position.
- Trunk remains upright and vertical.
- Take off leg trails during most of the flight.
- Take off leg is bent and drawn forwards and upwards near the end of the flight.
- Both legs are extended forwards for landing.

### COACHES SHOULD:

- Help novice athletes to use the appropriate technique.
- Observe the action of the limbs and position of the trunk.
- Ensure that any technique changes/progressions are optimal for the athlete.

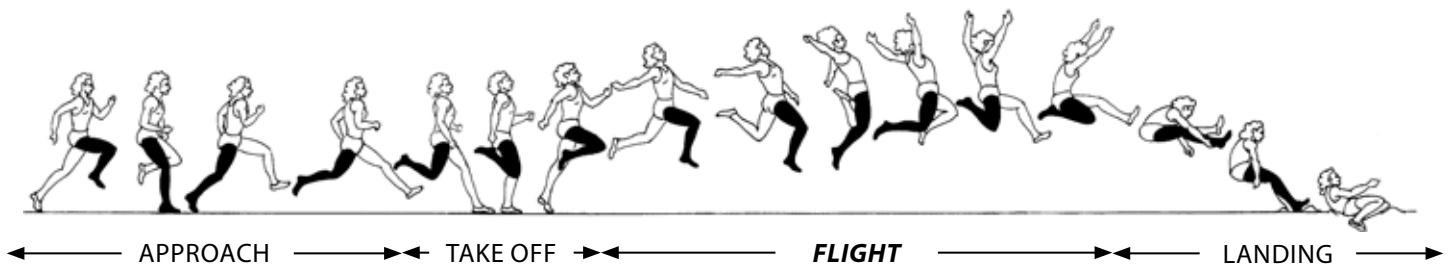

## FLIGHT PHASE

### *Hang Technique*



*Good technique especially for jumpers in the 6-7 metres range*

## Objective

To prepare for an efficient landing.

## Technical characteristics

- Free leg is lowered by rotating at the hip joint.
- Hips are pushed forwards.
- Take off leg is parallel to the free leg.
- Arms are in an upward-backward position.

### HELP ATHLETES TO:

- Use the appropriate technique for them to control forward rotation.
- Not rush the action - take off explosively, then perform the action.
- Understand that the approach and take off principally determine performance.

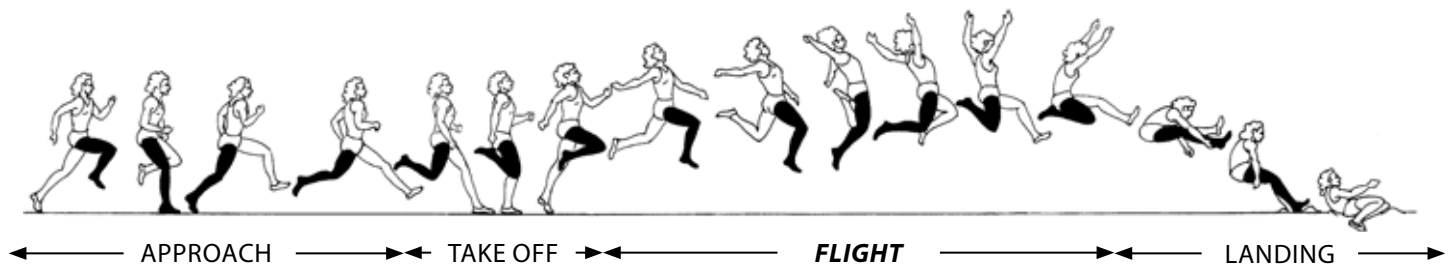

## FLIGHT PHASE

### *Hitch-kick Technique*



*Advanced technique for elite jumpers*

## Objective

To prepare for an efficient landing.

## Technical characteristics

- Running action continues in the air supported by arm swing.
- Stride rhythm of the approach should not be changed.
- Running action must be finished at landing, with both legs extended forward.
- Variations: 1½ or 2½ or 3½ strides during the flight.



## LANDING PHASE



### COACHES SHOULD:

- Maintain the condition and safety of the prepared pit during practice.
- Observe the position of the legs prior to landing and the action at landing.
- Ensure that feet are level at touchdown.

## Objective

To minimise the loss of distance.

## Technical characteristics

- Legs are almost fully extended.
- Trunk is bent forward.
- Arms are drawn backwards.
- Hips are pushed forwards toward the touchdown point.

### HELP ATHLETES TO:

- Extend legs out in front with body bending into landing.
- Time the lowering and collapse of the legs at touchdown so that they do not 'sit back'.

## STEP 1 CONSECUTIVE JUMPS OVER OBSTACLES

### OBJECTIVES:

To take off from a short approach and improve the take off position.



- Use a short approach using either take off leg.
- Land on the free leg.
- Use a 3-stride rhythm.
- Height: 30-50 cm
- Distance: 6-8 m (increases with speed)

### TIPS:

- Allow enough time for novices to determine their preferred take off leg.
- Look ahead rather than at the obstacle.
- Run and take off 'tall'.

## STEP 2 TELEMARJUMP OFF A PLATFORM

### OBJECTIVES:

To get used to jumping off a platform and increase the time in the air.

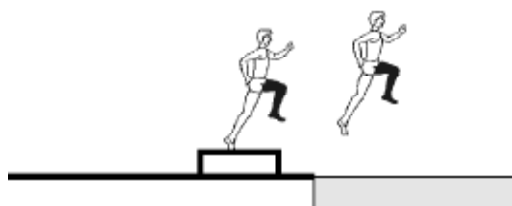

### TIPS:

- If using approach from side of pit - adjust position of platform so you land in middle of pit.
- Keep your approach to 5-7 strides.
- Take off and 'hold' position.

- Use a 5-7 step approach.
- Hold the take off position in the air.
- Approach from the runway (small group) or side of the pit (large group).
- Land in stride position (telemark).
- Height of platform: 15-25 cm.

## STEP 3 TELEMARJUMP

### OBJECTIVES:

To emphasise the take off movement and 'freeze' the take off position.



- Use a 5-7 step approach.
- Hold the take off position in the air.
- Approach from the runway (small group) or side of the pit (large group).
- Land in a 'stride' position (telemark).

### TIPS:

- If using approach from side of pit - adjust take off point so you land in middle of pit.
- Keep your approach to 5-7 strides.
- Take off and 'hold' position.

## STEP 4 SAIL TECHNIQUE OFF A PLATFORM

### OBJECTIVES:

To practise technique with assisted take off.

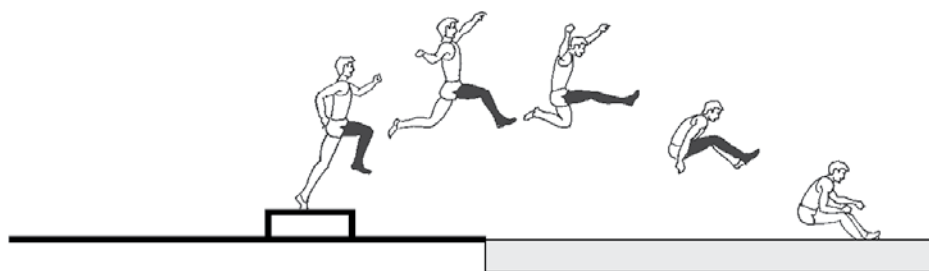

### TIPS:

- Don't rush the action.
- Let the action in the air develop naturally.
- Relax into the landing.

- Use a 5-7 step approach.
- Hold the take off position in the air.
- Extend the free leg before landing.
- Draw the take off leg forwards-upwards.
- Land with feet level.

## STEP 5 SAIL TECHNIQUE FROM A SHORT APPROACH

### OBJECTIVES:

To practise the sail technique.

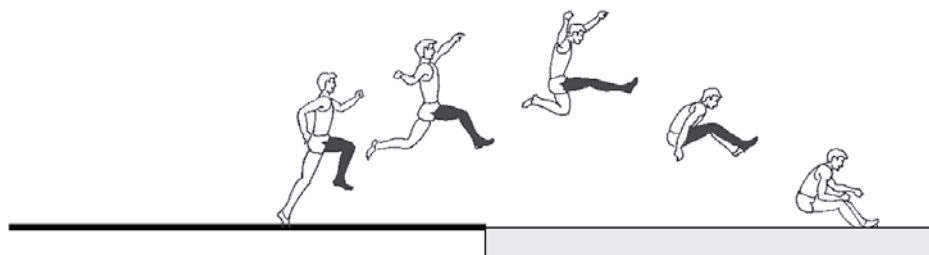

### TIPS:

- Don't rush the action.
- Let the action develop naturally.
- Relax into the landing.

- Turn through 180° balanced on the heel of left foot, pivoting on to the ball of right foot.
- Continue turn another 180° balanced on the ball of the left foot while lifting the right foot.
- Place the right foot down to complete a 360° turn.

## STEP 6 WHOLE SEQUENCE FROM A FULL APPROACH

### OBJECTIVES:

To set approach length and link the complete movement.



- Use back straight of the track to determine the length of the approach.
- Sprint an appropriate number of strides three times and coach or partner marks spot.
- Average length is 'pigeon stepped' (foot lengths) out and then measured on runway.
- This approach and complete Sail technique is practiced and, if necessary, adjustments made to starting mark.

### TIPS:

- Approach should only be as long as it takes to reach maximum controllable speed.
- Run the back straight as you would the approach on the runway.
- Focus ahead and don't look for the take off board.





# TRIPLE JUMP





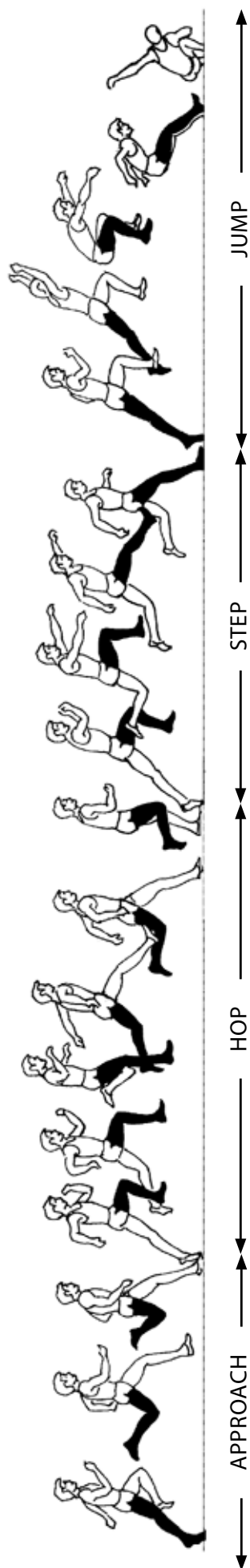

## Triple Jump – Whole Sequence



### Phase Description

The triple jump is divided into the following phases: APPROACH, HOP, STEP, and JUMP. The hop, step and jump phases can each be divided into the typical phases for the jumps: TAKE OFF, FLIGHT and LANDING.

- In the approach phase the jumper accelerates to a maximum controllable speed.
- In the hop phase the jumper executes the movement quickly and flatly, covering about 35% of the overall distance.
- In the step phase the jumper covers about 30% of the overall distance. The step is the most critical part of the triple jump. Its duration should be equal to the hop.
- In the jump phase the athlete takes off with opposite leg and covers about 35% of the overall distance.

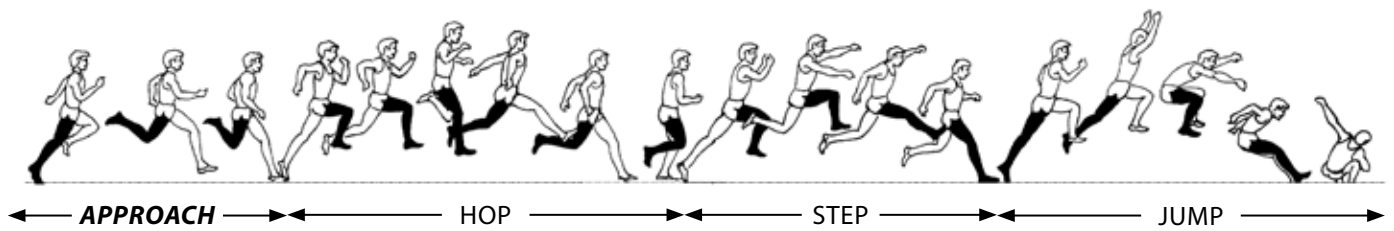

## APPROACH PHASE

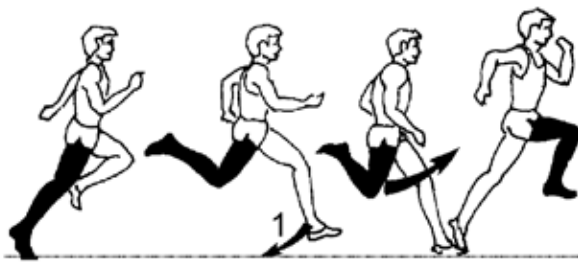

### Objective

To reach maximum velocity and position the body for the take off.

### Technical characteristics

- Approach length varies between 10 strides (for beginners) and more than 20 strides (for experienced, elite jumpers).
- Running technique is similar to sprinting.
- Stride frequency is increased at the end of the approach.
- Velocity is increased continuously throughout the approach.
- Foot plant is active and quick with a 'down and back' motion. (1)

#### COACHES SHOULD:

- Observe the whole approach.
- Utilise check marks where appropriate.
- Observe the overall rhythm of the approach.
- Observe one component of phase at a time.
- Observe limb, joint and body actions and angles.

#### HELP ATHLETES TO:

- Run naturally and lightly.
- Run evenly and balanced.
- Accelerate to the maximum controllable speed.

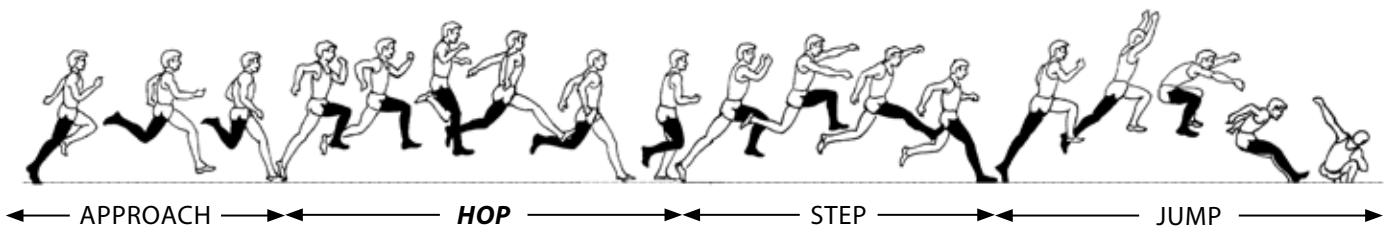

## HOP PHASE



### Objective

To achieve a long, flat flight with a minimal loss of horizontal velocity.

#### COACHES SHOULD:

- Ensure the hop is quick and flat.
- Ensure that the hop covers about  $\frac{1}{3}$  of the overall distance.
- Check take off direction is forward and not upward.
- Observe from front and side.

### Technical characteristics

- Thigh of the free leg is driven to the horizontal position.
- Take off direction is forward, not upward. (1)
- Free leg is drawn back.
- Take off leg is drawn forwards-upwards then extended forwards to prepare for touchdown. (2)
- Trunk is kept upright.

#### HELP ATHLETES TO:

- Fully extend take off leg and then keep it 'active'
- Drive free leg forwards.
- Remain balanced.
- Maintain velocity.

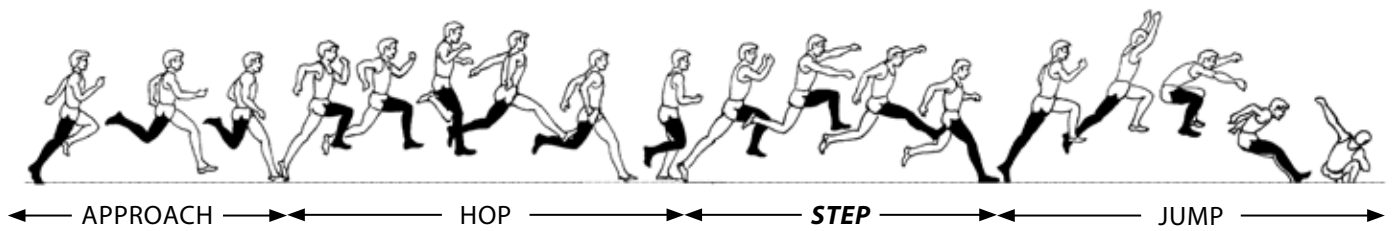

## STEP PHASE



### COACHES SHOULD:

- Observe from the side and front.
- Ensure that the step covers about  $\frac{1}{3}$  of the overall distance.
- Ensure the athlete has overall conditioning for the event.
- Use hopping and stepping drills to stabilise triple jump action.

## Objective

To equal the duration of the hop, i.e. to achieve the same height as in the hop

## Technical characteristics

- Foot plant is active and quick with a 'down and back' motion.
- Lead leg is almost completely extended.
- Double arm swing is used, if possible.
- Thigh of the free leg is horizontal, or higher. (1)
- Trunk position is upright.
- Free leg is extended forwards-downwards. (2)

### HELP ATHLETES TO:

- Achieve the same height as the hop.
- Try double arm swing.
- Keep trunk position upright.
- Bring the thigh of the free leg to horizontal or above in the flight.

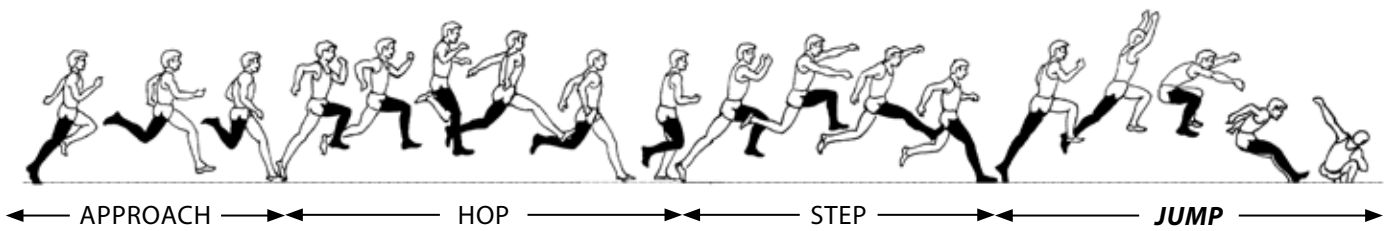

## JUMP PHASE



### COACHES SHOULD:

- Observe from front and side.
- Encourage a very active 'down and back' action in the foot plant.
- Ensure that opposite leg is strong and enables the athlete to balance and drive.
- Encourage a sail or hang technique and devise practices as necessary.

## Objective

To take off powerfully at an optimum take off angle. (1)

## Technical characteristics

- Foot plant is active and quick with a 'down and back' motion.
- Support leg is almost straight during take off.
- Double arm action is used if possible. (2)
- Body position is upright.
- Hang or sail technique are used in the air.
- Legs are almost fully extended at landing.

### HELP ATHLETES TO:

- Achieve a jump which is about  $\frac{1}{3}$  of the total distance.
- Use free limbs to increase drive.
- Extend legs out in front with body bending into landing.

## STEP 1 RHYTHMIC JUMPING

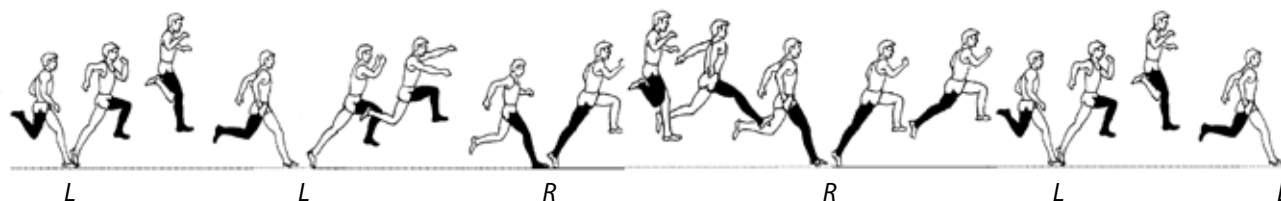

### OBJECTIVES:

To improve general jumping ability using both legs for take off.

- Use a 3-5 step approach.
- Consecutive alternate bounds.
- Consecutive hops.
- Use various combinations of bounds and hops.

### TIPS:

- Allow enough time for beginners to determine the preferred take off leg.
- Feel the rhythm
- Run, hop, bound and take off 'tall'!

## STEP 2 MULTIPLE TRIPLE JUMP

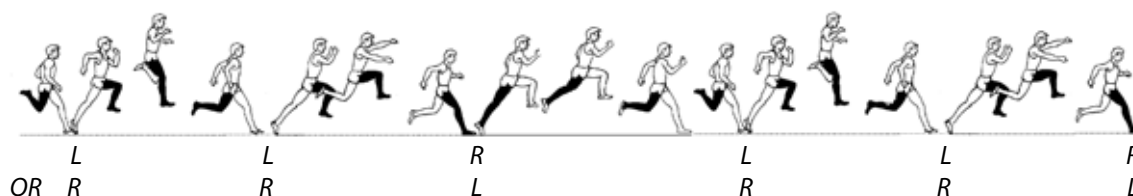

### TIPS:

- If there is difficulty in coordination think or say, "same, other, both."
- Achieve rhythm over distance.
- Keep the legs active at all times.

### OBJECTIVES:

To get used to the triple jump rhythm.

- Use a 3-5 step approach.
- Use the triple jump rhythm.
- Keep the rhythm of the hop and step even.
- Distance: 20-30 m.

## STEP 3 TRIPLE JUMP WITH STEP TO PLATFORM

### OBJECTIVES:

To improve step technique.

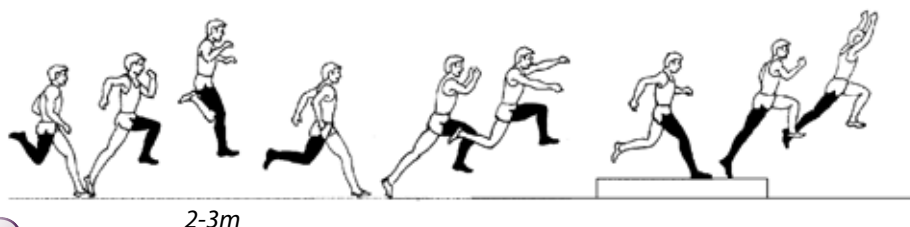

### TIPS:

- If using approach from side of pit - adjust position of platform so you land in middle of pit.
- Keep your approach to only 5-7 strides.
- Keep all take offs active.

- Use a 5-7 steps approach.
- Mark a gap (2-3 m) for the hop and position a 15-25 cm platform.
- After the hop step on to the platform
- Jump into the pit.



## STEP 4 TRIPLE JUMP GRID

### OBJECTIVES:

To avoid over-emphasis on the hop.

#### TIPS:

- Use the coach or partner to observe where you take off.
- Achieve rhythm over distance.
- Keep the legs active at all times.

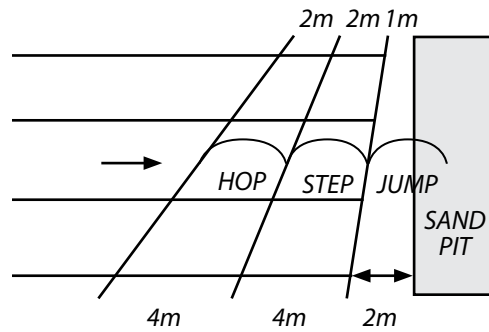

- Mark out an angled grid along side of the pit.
- Use a 5-7 steps approach from the side of the pit.
- Hop and step into the grid.
- Move down the grid, increasing distance as long as rhythm is maintained.

## STEP 5 TRIPLE JUMP FROM A MEDIUM APPROACH



### OBJECTIVES:

To get used to higher approach speeds and harder surfaces.

- Use runway for the approach.
- Use 7-9 step approach.
- Keep the rhythm for the hop and step even.

#### TIPS:

- Develop speed of approach that can be maintained through the whole jump.
- Look ahead to maintain balance.
- Use a take off point which puts the step safely on the runway.

## STEP 6 WHOLE SEQUENCE FROM A FULL APPROACH

### OBJECTIVES:

To set the approach length and link the complete movement.



#### TIPS:

- Run the back straight as you would the approach on the runway.
- Focus ahead and don't look for the take off board.

Use back straight of the track to determine the length of the approach.

- Sprint an appropriate number of strides three times and coach or partner marks spot.
- Average length is 'pigeon stepped' (foot lengths) out and then measured on runway.
- This approach and complete triple jump technique is practiced and, if necessary, adjustments made to starting mark.



# HIGH JUMP





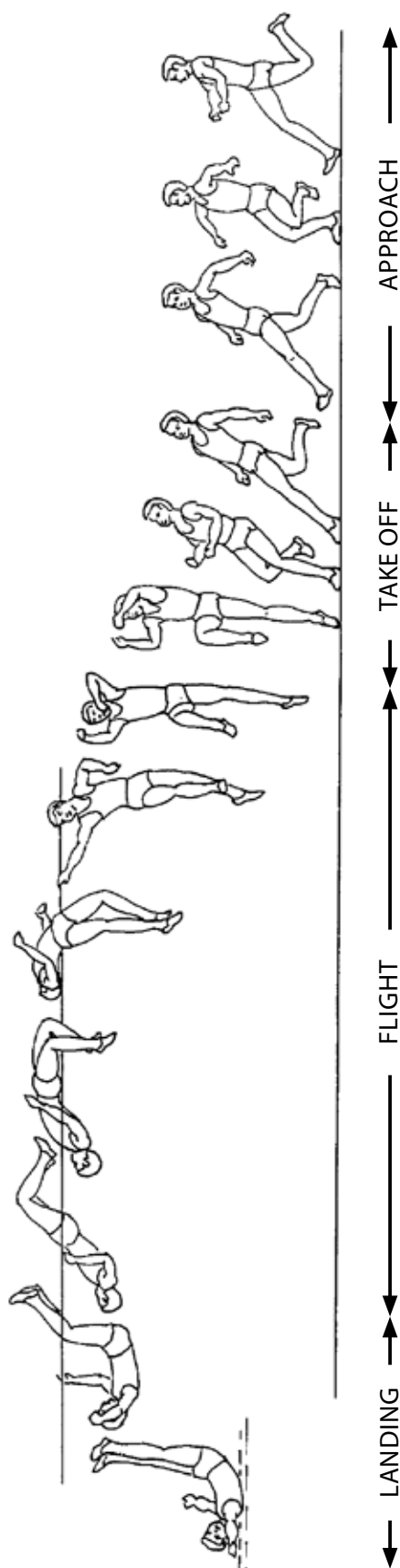

## High Jump– Whole Sequence



### Phase Description

The high jump is divided into the following phases: APPROACH, TAKE OFF, FLIGHT and LANDING.

- In the approach phase the jumper accelerates and prepares for the take off.
- In the take off phase the jumper generates vertical velocity and initiates rotations necessary for bar clearance.
- In the flight phase the jumper rises to the bar and then clears it.
- In the landing phase the jumper safely completes the jump.

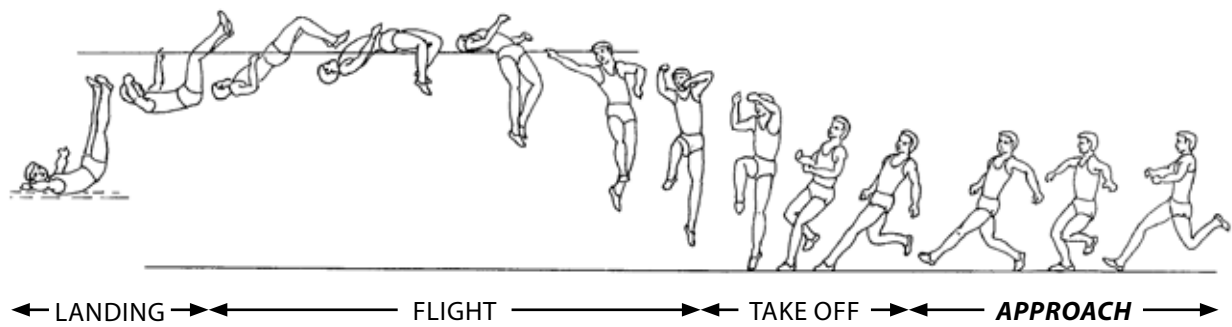

## APPROACH PHASE

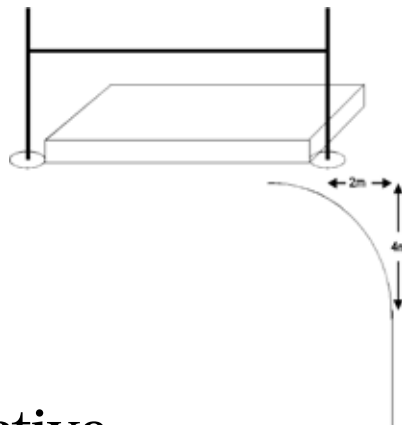

### COACHES SHOULD:

- Observe from the side and rear.
- Observe that the athlete's acceleration is optimal and body lean is appropriate.
- Ensure that there is no slowing down.

## Objective

To generate optimum (not maximum) speed.

## Technical characteristics

- Approach run is J-shaped: straight at first (3-6 strides), then curved (4-5 strides).
- Foot plant for the first strides is on the ball of the foot.
- Body lean is moderately forward for the first strides.
- Velocity is increased continuously throughout the approach.

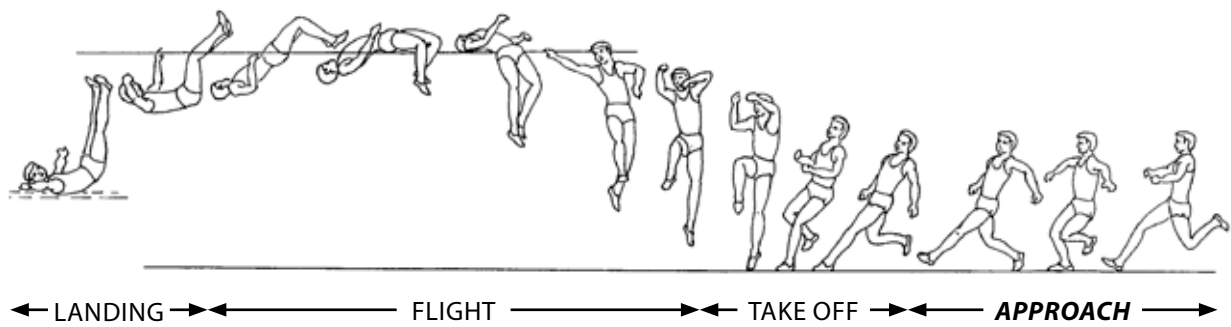

## APPROACH PHASE

### *Final Strides*

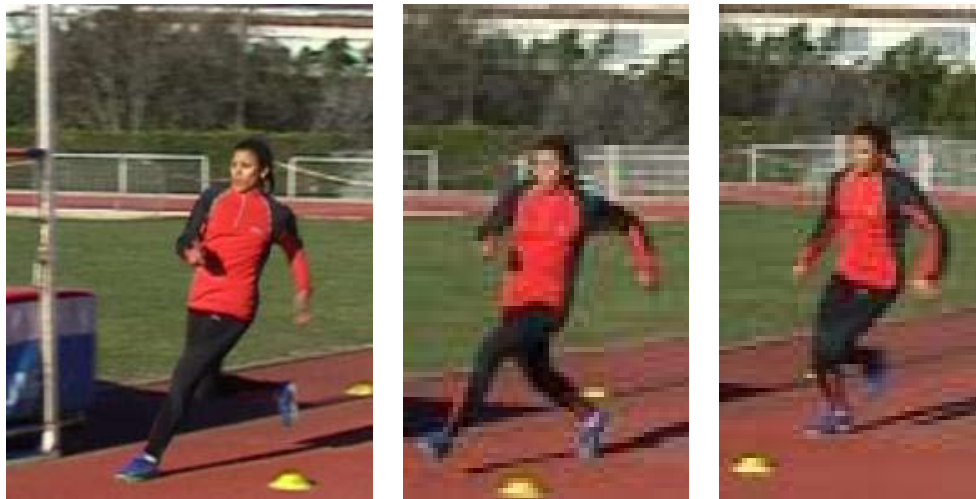

## Objective

To minimise the loss of speed and prepare for an effective take off.

## Technical characteristics

- Stride frequency is increased continuously.
- Body leans inward, the angle is dependent on the approach speed.
- Forward lean is reduced and body is upright.
- Centre of mass is lowered moderately in the penultimate stride.
- Active drive of the right foot in the penultimate stride.

### HELP ATHLETES TO:

- Determine the optimum number of strides for their approach.
- Gain confidence in leaning naturally into the curve.
- Feel the acceleration into the jump.

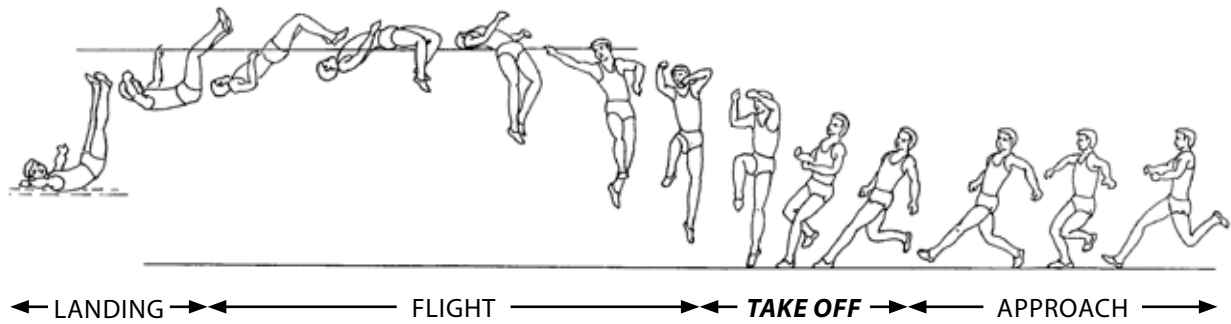

## TAKE OFF PHASE



### COACHES SHOULD:

- Observe from the side and rear.
- Observe the speed and extension of the ankle, knee and hip joints.
- Observe the position of the free leg.

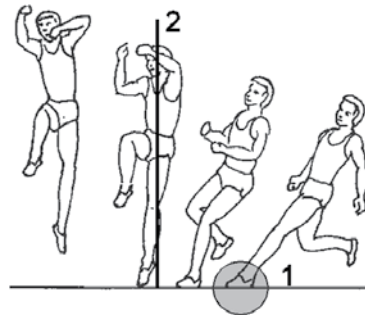

### Objective

To maximise vertical velocity and to initiate rotations necessary for bar clearance.

### Technical characteristics

- Foot plant is active, quick and flat with a 'down and back' motion. (1)
- Take off foot points towards the landing area.
- Time on ground and the bending of the take off leg are both minimised.
- Knee of free leg is driven up until the thigh is parallel with the ground.
- Body is vertical at the end of the take off. (2)

### HELP ATHLETES TO:

- Accelerate into the jump.
- Drive the free leg quickly through to the horizontal position and stop.
- Develop the strength so the take off leg does not collapse.



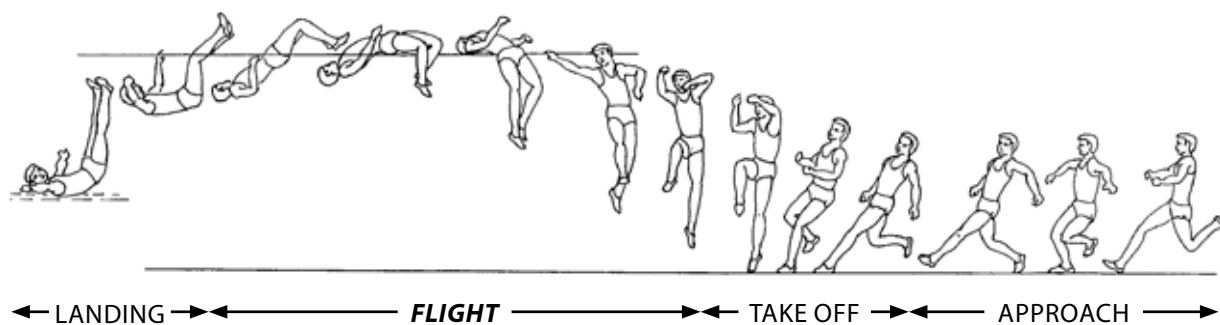

## FLIGHT PHASE

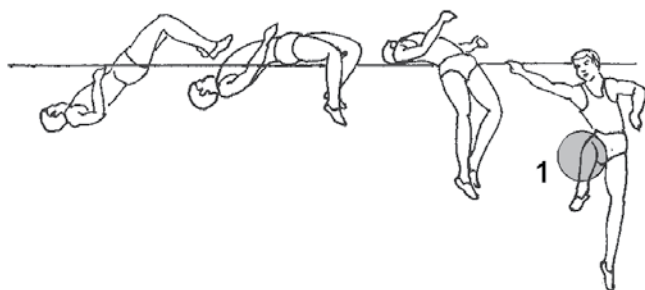
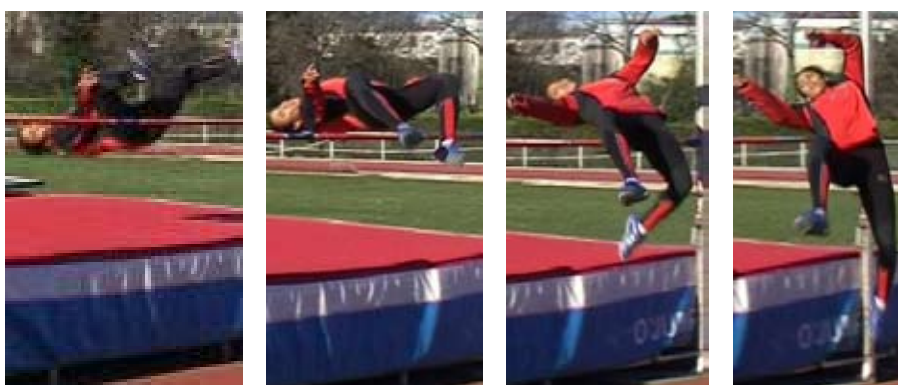

### COACHES SHOULD:

- Observe the action of the limbs and arching of the trunk.
- Ensure that any actions in the air aid bar clearance and put the body into a safe position for landing.

## Objective

To clear the bar.

## Technical characteristics

- Take off position is held as the body gains height. (1)
- Leading arm is fixed or reaches up, across and over the bar.
- Hips are raised over the bar by arching the back and lowering legs and head.
- Knees are spread to allow more body arch.

### HELP ATHLETES TO:

- Not rush the action - take off explosively, then perform the action to clear the bar.
- Understand that the approach and take off principally determine performance.
- 'Chin to chest' after clearing the bar.

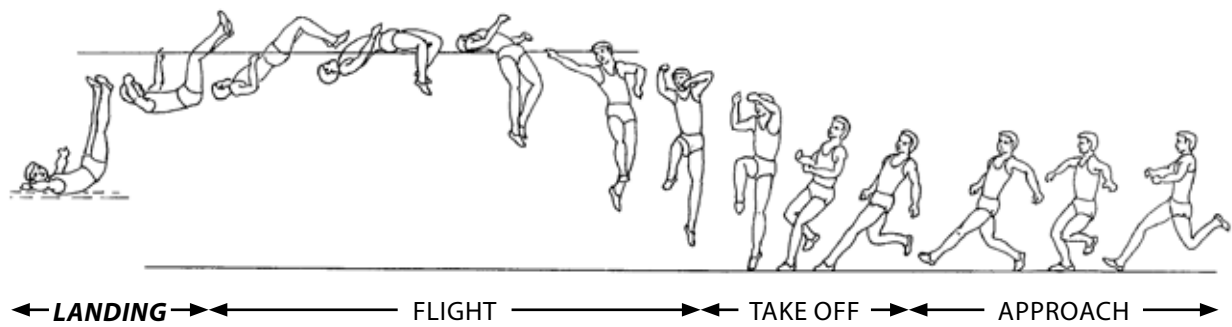

## LANDING PHASE



### COACHES SHOULD:

- Ensure that the landing area is safe and maintain safety during the session.
- Observe the position of the head and legs prior to landing and the actions at landing.

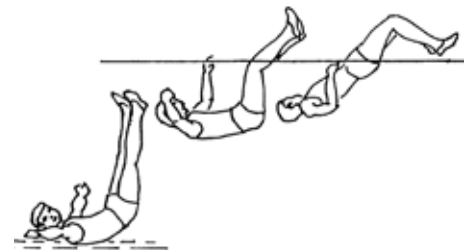

## Objective

To land safely and avoid injury.

## Technical characteristics

- Head is drawn towards the chest.
- Landing is on the shoulders and back.
- Knees are apart for touch down.

### HELP ATHLETES TO:

- Relax at landing.
- Keep the head towards the chest after crossing the bar.
- Enjoy a safe environment.



## STEP 1 SCISSORS JUMP

### OBJECTIVES:

To improve the vertical take off.

#### TIPS:

- Accelerate into the jump.
- Keep your approach to 5-7 strides.
- Take off and 'hold' an upright position while you 'scissor' your legs.

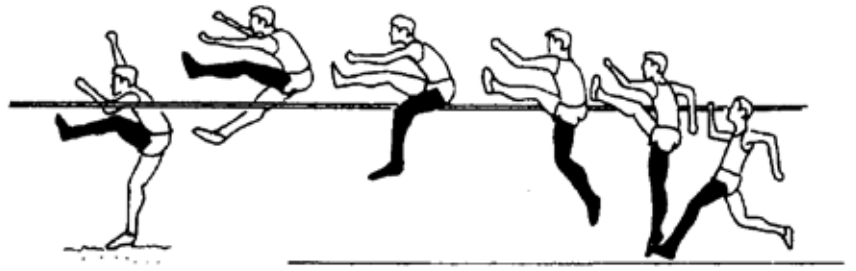

- Use straight approach.
- Plant take off foot in line of approach.
- Gradually increase height.
- Use standing landings only - on free leg.

## STEP 2 CURVE RUNNING

### OBJECTIVES:

To feel the inward lean and the rhythm of the approach.

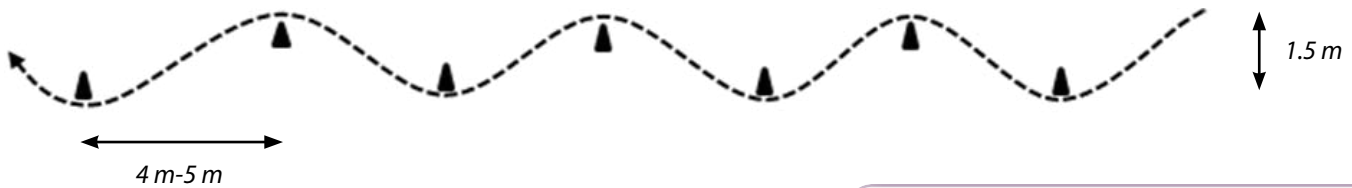

- Run in and out of cone markers.
- Run fast but controlled.
- Increase speed when entering each curve.
- Variations: 'high-knees' or high frequency.

#### TIPS:

- Fast into the curves.
- Look ahead rather than at the markers.
- Run 'tall' even when leaning.

## STEP 3 SCISSORS JUMP FROM CURVE RUNNING

### OBJECTIVES:

To learn to jump vertically off a curved approach.

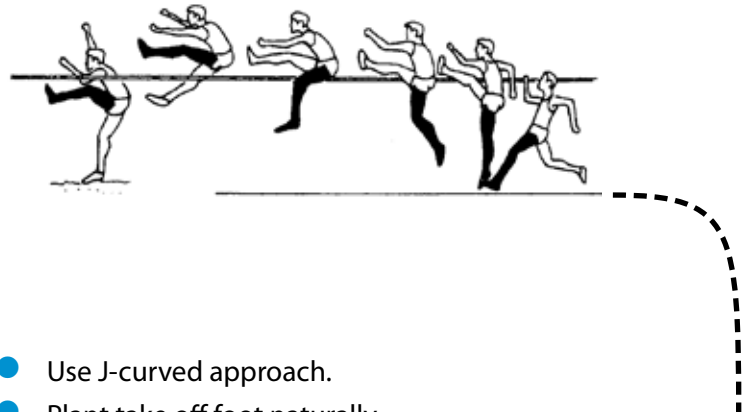

#### TIPS:

- Run the curve fast but controlled.
- Accelerate into the jump.
- Take off and 'hold' upright position.

- Use J-curved approach.
- Plant take off foot naturally.
- Gradually increase height.
- Use standing landings on sand - on free leg.

## STEP 4 STANDING FLOP

### OBJECTIVES:

To improve bar clearance.

#### TIPS:

- Ensure the landing area and bar are safe.
- Don't rush the action.
- Let the action develop naturally.
- Relax into the landing.

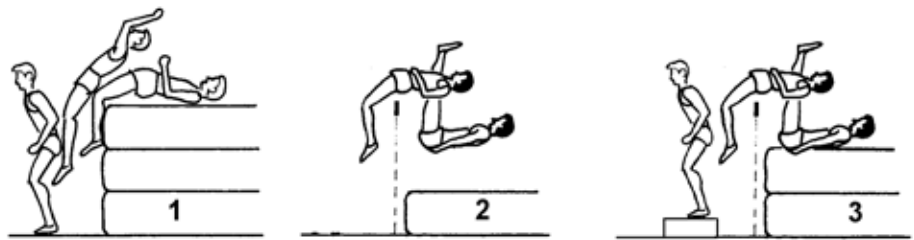

- Take off from the ground (1) or a box (3).
- Use different landing heights.
- Open knees at clearance and landing.
- Use uprights with a rope or a bar (2, 3).

## STEP 5 FLOP FROM A HIGH-KNEE APPROACH

### OBJECTIVES:

To improve the rhythm of the final strides.



- Mark a J-curve and starting point.
- Use a 5-7 stride high-knee approach.
- Use high stride frequency.
- Do not lower the hips in preparation for take off.

#### TIPS:

- Accelerate into the curve and take off.
- At take off bring the free leg quickly to horizontal and 'hold'.

## STEP 6 WHOLE SEQUENCE

### OBJECTIVES:

To practise the complete movement with increasing speed.

#### TIPS:

- Develop the approach rhythm.
- Volume is determined by number of take offs.
- Take off before starting to clear the bar.



- Mark a J-curve and the starting point.
- Start with shortened approach (4-6 strides).
- Gradually increase approach length and speed.



# POLE VAULT







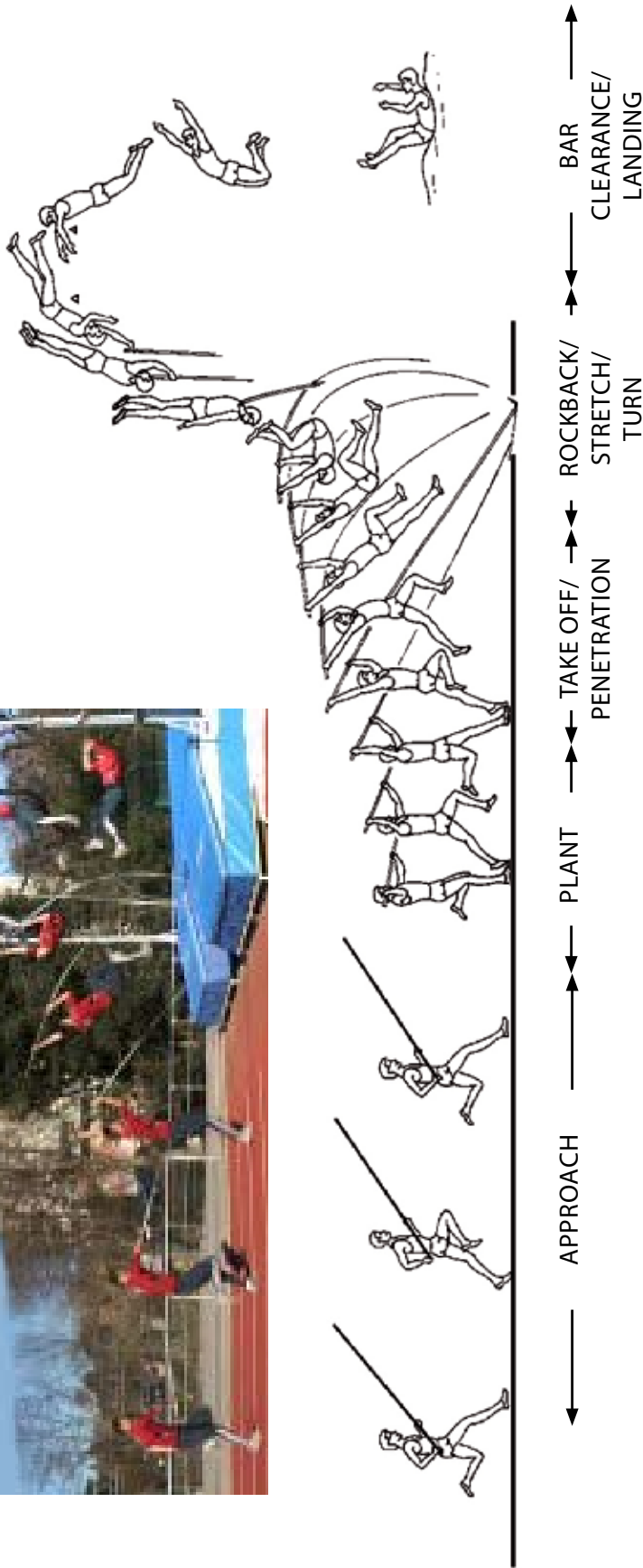

## Pole Vault – Whole Sequence

### Phase Description

The pole vault is divided into the following phases: APPROACH, PLANT, TAKE OFF and PENETRATION, ROCKBACK and STRETCH/TURN, BAR CLEARANCE and LANDING.

- In the approach and plant phases the vaulter accelerates to maximum controllable speed and smoothly positions the pole for the take off.
- In the take off and penetration phase energy from the approach is transferred to the pole.
- In the rockback and stretch/turn phase energy is stored in the pole then utilised to raise the vaulter.
- This is assisted by additional muscle actions.
- The bar clearance phase is the completion of the vault and the start of preparation for a safe landing.

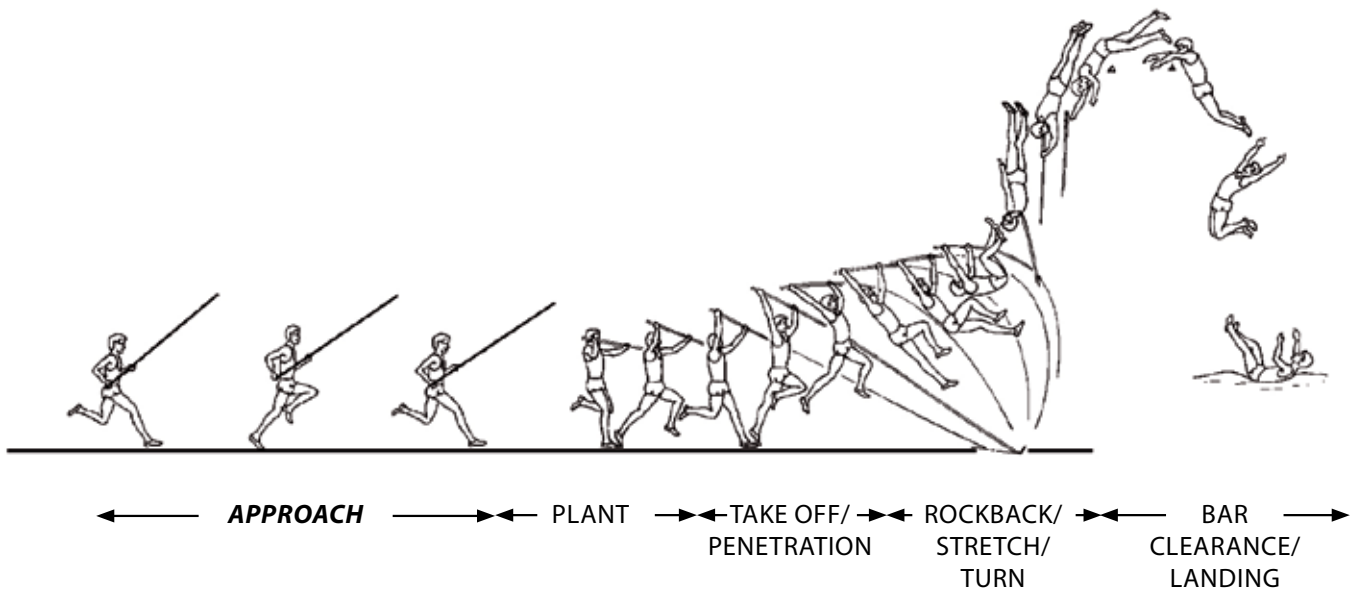

## GRIP AND CARRY POSITION

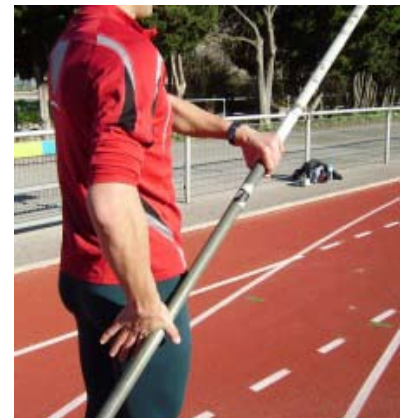
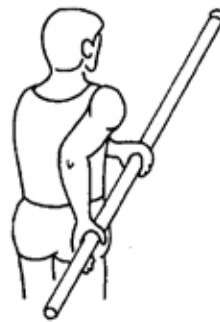

### Objective

To hold the pole correctly for the approach run and plant.

### Technical characteristics

- Hands are shoulder-width apart. Right hand is higher on the pole.
- Both arms are bent, the right hand is close to the hip.
- Tip of the pole is above head height.
- Elbow of the left arm points to the side.
- Upper body is upright.

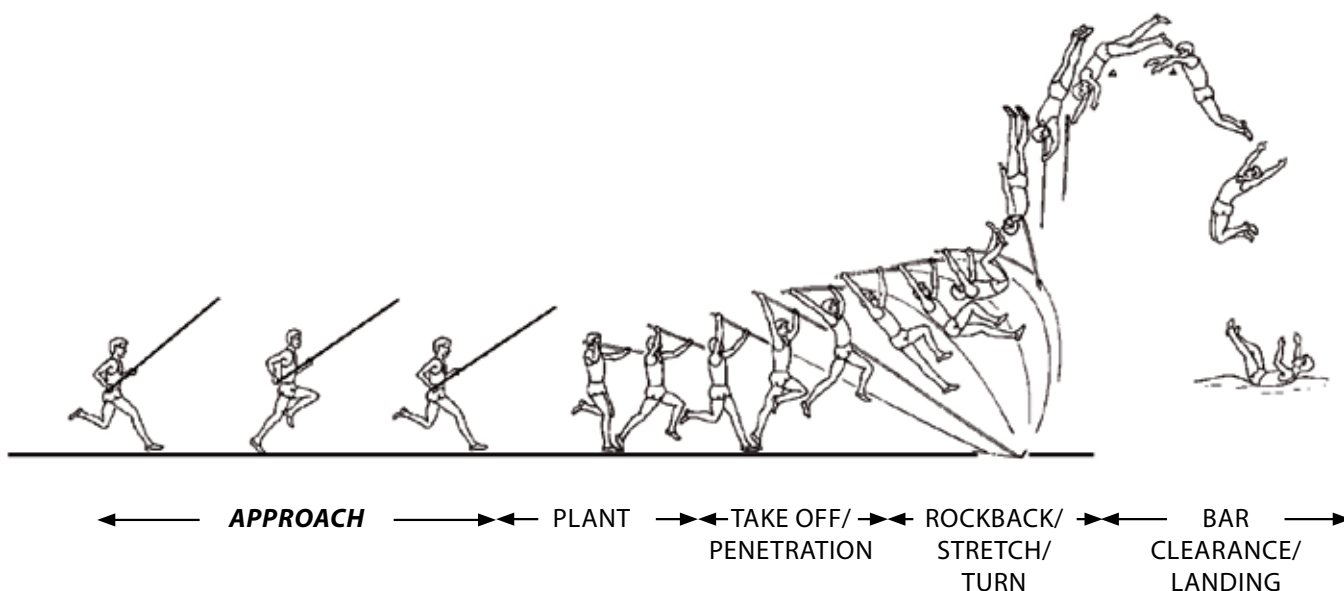

## APPROACH



### Objective

To minimise the loss of speed and Prepare for an effective plant phase.

### Technical characteristics

- The approach is active and with gradual acceleration.
- Elbows are relaxed; the pole should not disturb the approach.
- The pole is held obliquely forward then is carried horizontally during the run.

#### COACHES SHOULD:

- Ensure that poles and all equipment are suitable for the athlete.
- Observe from the side and rear.
- Observe that the athlete's acceleration is optimal with an effective pole carry.

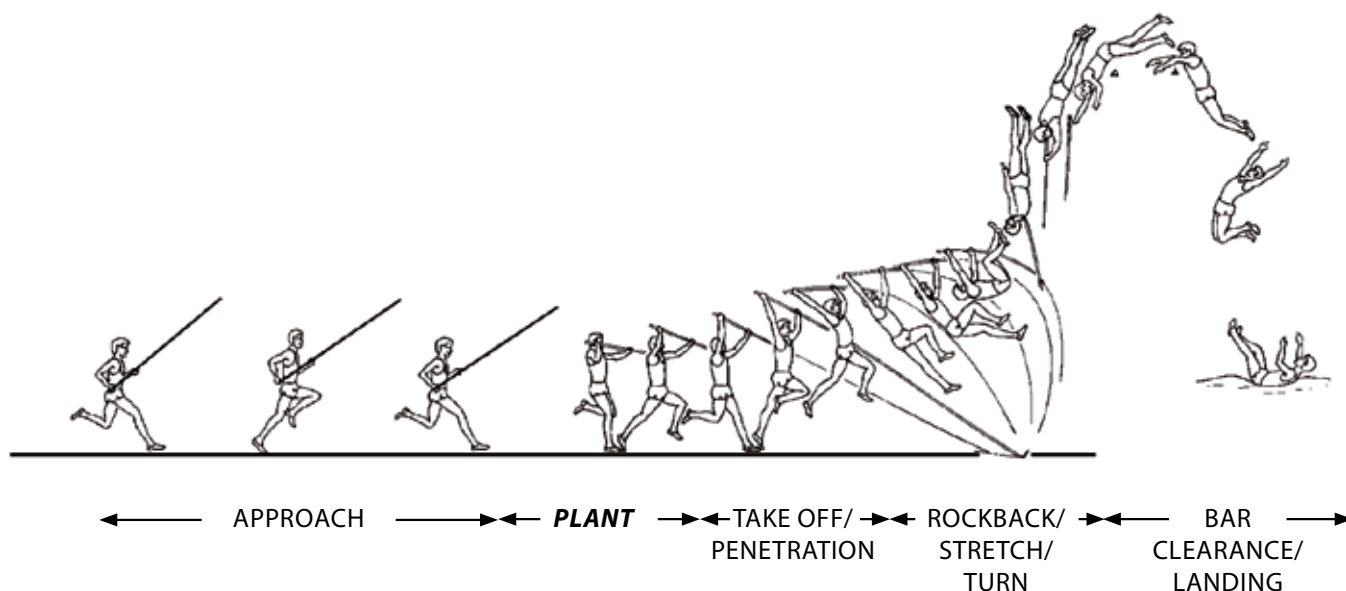

## PLANT PHASE

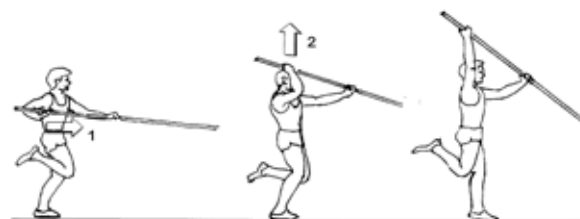
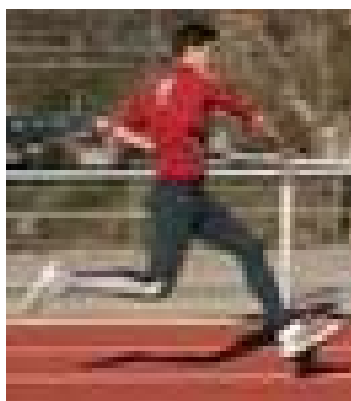

### Objective

To position the pole in preparation for the take off while minimising the loss of speed.

### Technical characteristics

- Tip of the pole is lowered gradually and smoothly in the last third of the approach.
- Plant commences on the penultimate contact of the left foot with a forward push of the pole. (1)
- Right arm is raised quickly, the hand pushing close to the head at the contact of the right foot. (2)
- Body is upright with the shoulders square to the box.

#### HELP ATHLETES TO:

- Determine the optimum number of strides for their approach.
- Feel the acceleration into the plant.
- Develop a strong, smooth plant.

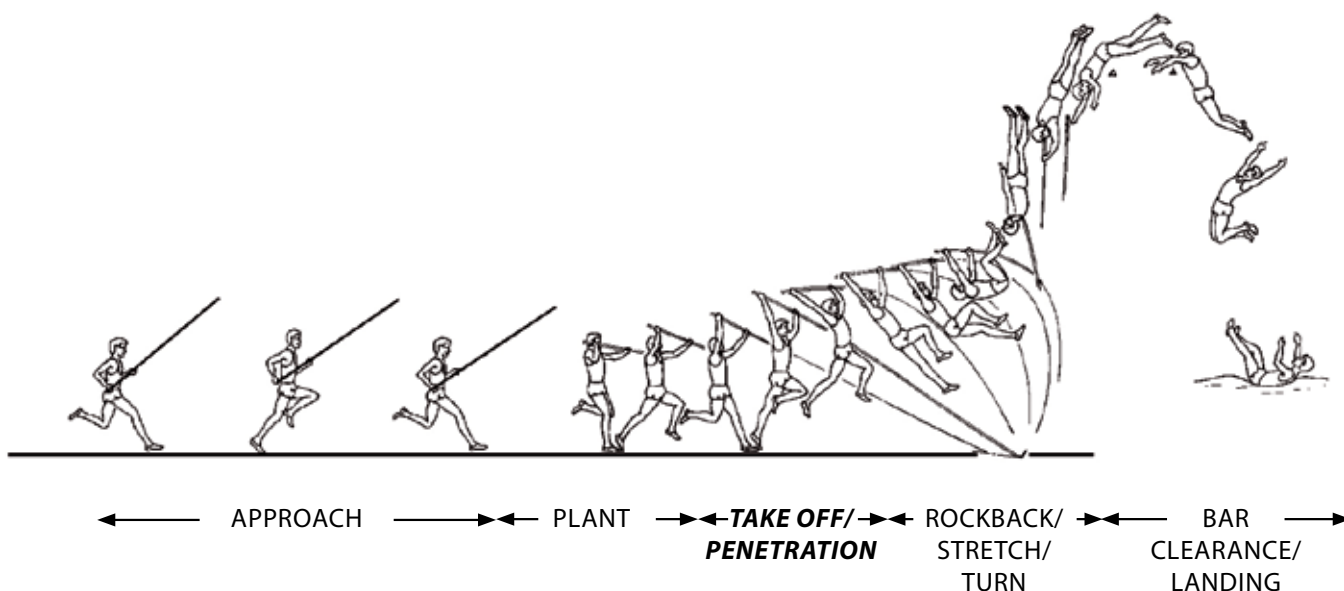

## TAKE OFF/PENETRATION PHASE

### *Take off*



#### COACHES SHOULD:

- Observe from the side and rear.
- Observe the body is stretched upwards and the position of the upper hand over the take off foot.
- Observe the position of the free leg.



### Objective

To transfer maximum energy to the pole.

### Technical characteristics

- Foot plant is active and on the entire sole.
- Body is completely stretched with the right arm fully extended.
- Upper (right) hand is directly above or in front of the take off foot. (1)
- Thigh of the free leg swings actively forwards. (2)

#### HELP ATHLETES TO:

- Accelerate into the take off.
- Keep the lower arm under control so that it does not collapse.
- Maintain the forward focus at take off.

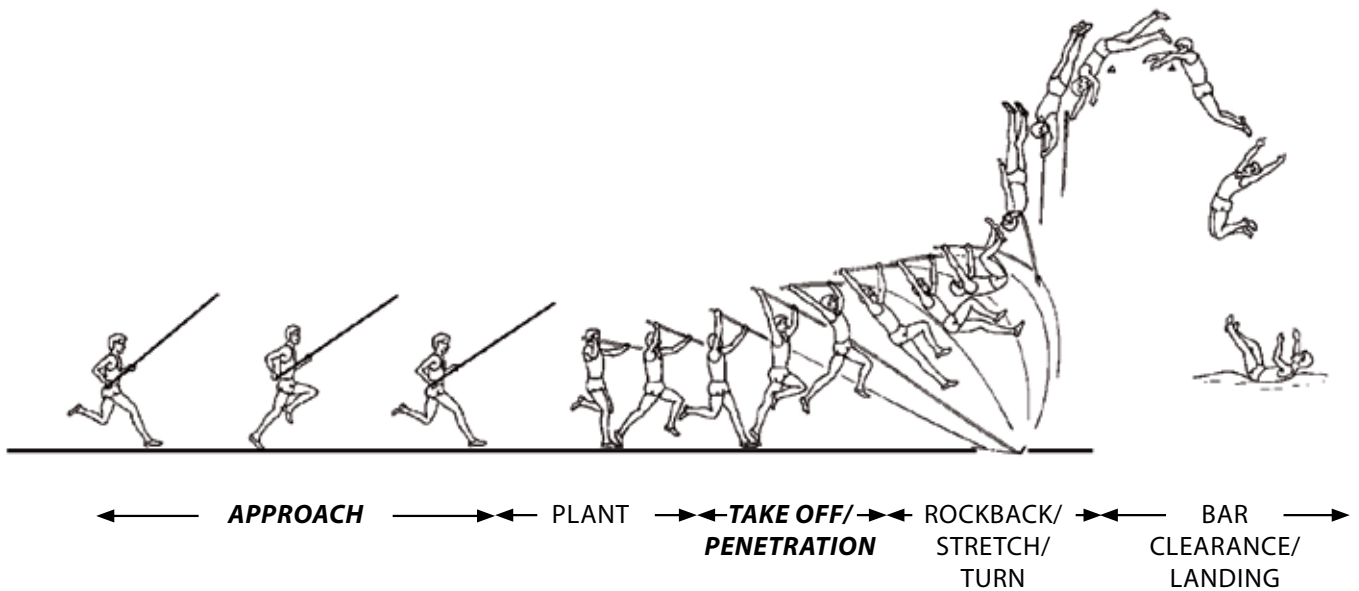

# TAKE OFF/PENETRATION PHASE

## *Penetration*

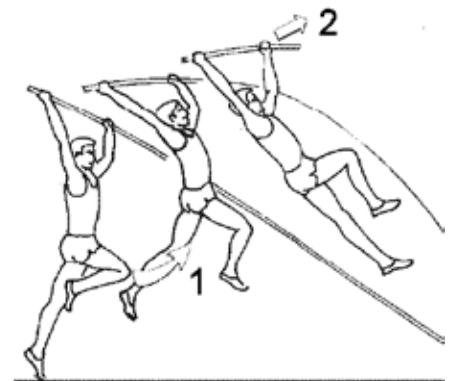

## Objective

To transfer maximum energy to the pole.

## Technical characteristics

- Vaulter 'freezes' in the take off position.
- Long pendulums are created around both the shoulders and the hips. (1)
- Left arm is pushed forwards and upwards. (2)
- Right arm is fully extended.

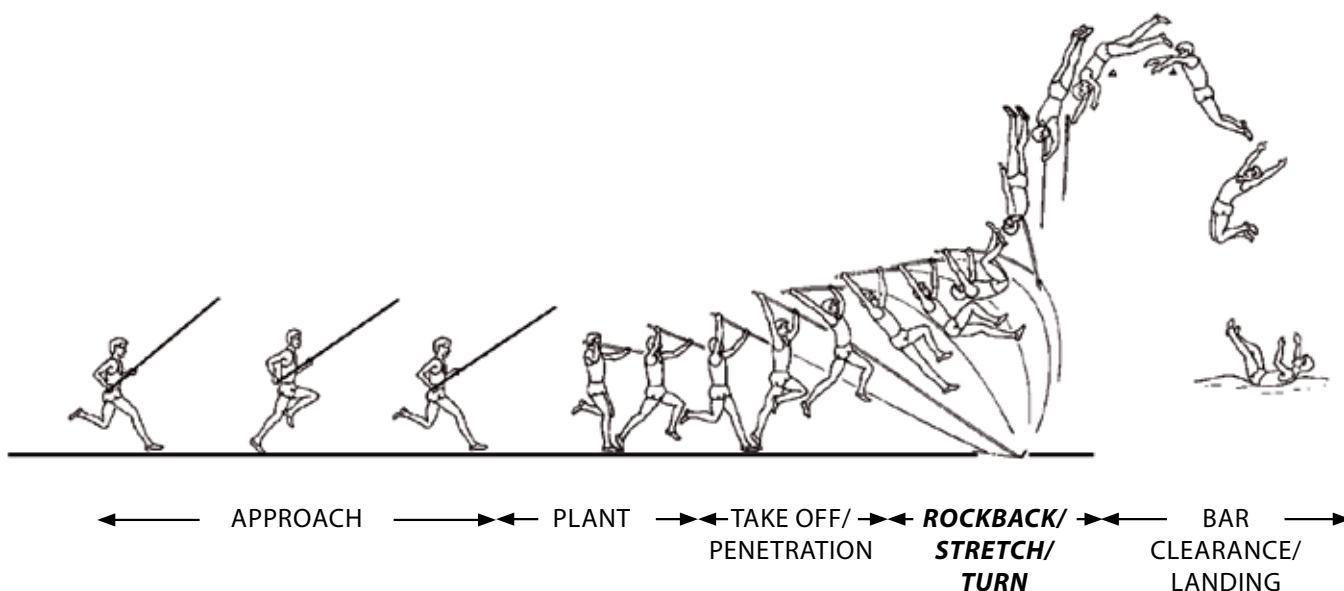

## ROCKBACK/STRETCH/TURN PHASE

### *Rockback*

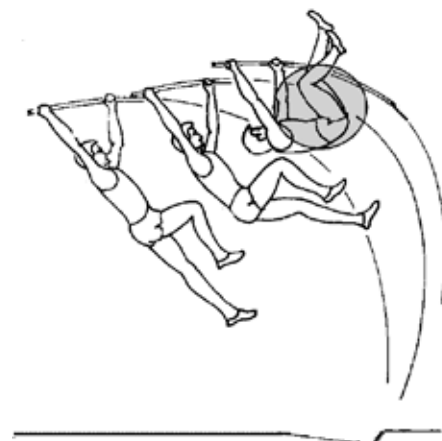

### Objective

To achieve maximum bend of the pole (storing energy) and to position the body to utilise the stored energy.

### Technical characteristics

- Both legs are bent and drawn to the chest.
- Both arms are extended.
- Back is roughly parallel to the ground. (1)

#### HELP ATHLETES TO:

- Travel forwards then upwards.
- Not rush the action, using a controlled 'ride' on the pole.
- Push off confidently and positively.
- Move quickly to clear the bar.

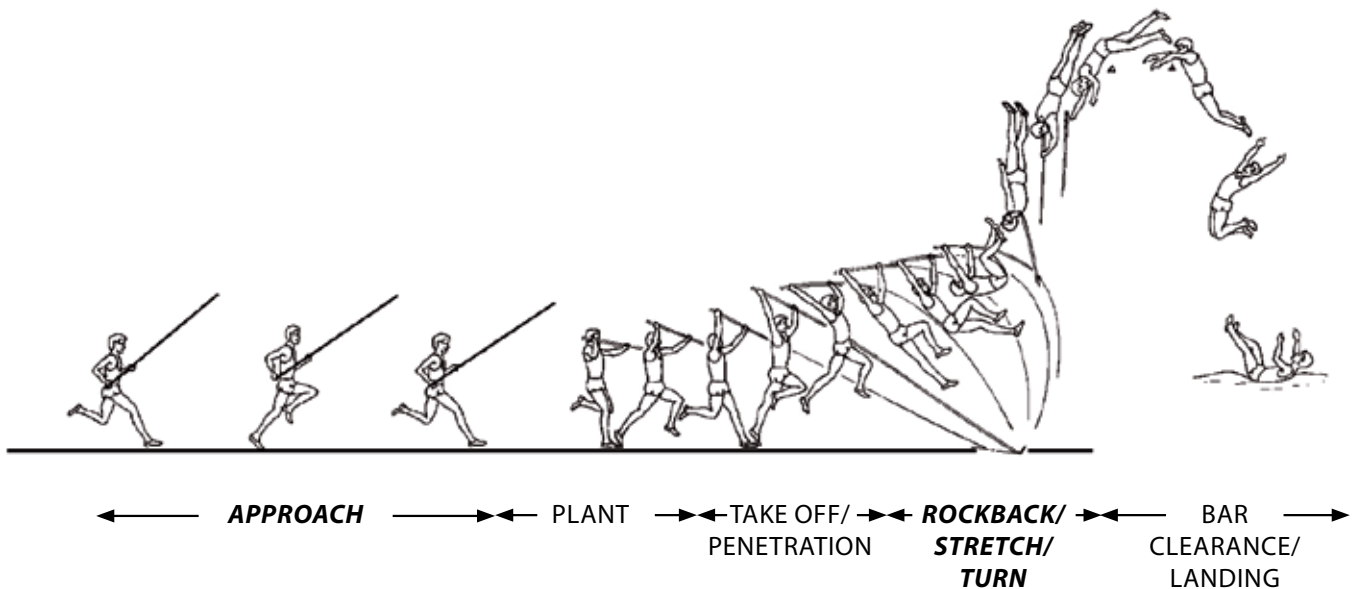

# ROCKBACK/STRETCH/TURN PHASE

## *Stretch and Turn*



## Objective

To use energy from the pole to lift the vaulter.

## Technical characteristics

- Body moves from the 'L' to the 'I' position.
- Right arm is extended, left arm bends with the elbow on the right side of the pole.
- Hips pass close to the pole.
- Turn is commenced with the pull of both arms.
- Body turns to face the bar.

### COACHES SHOULD:

- Observe the action of the limbs and the trunk throughout this phase.
- Practice timing for push off pole.
- Ensure that any actions in the air aid bar clearance and put the body into a safe position for landing.



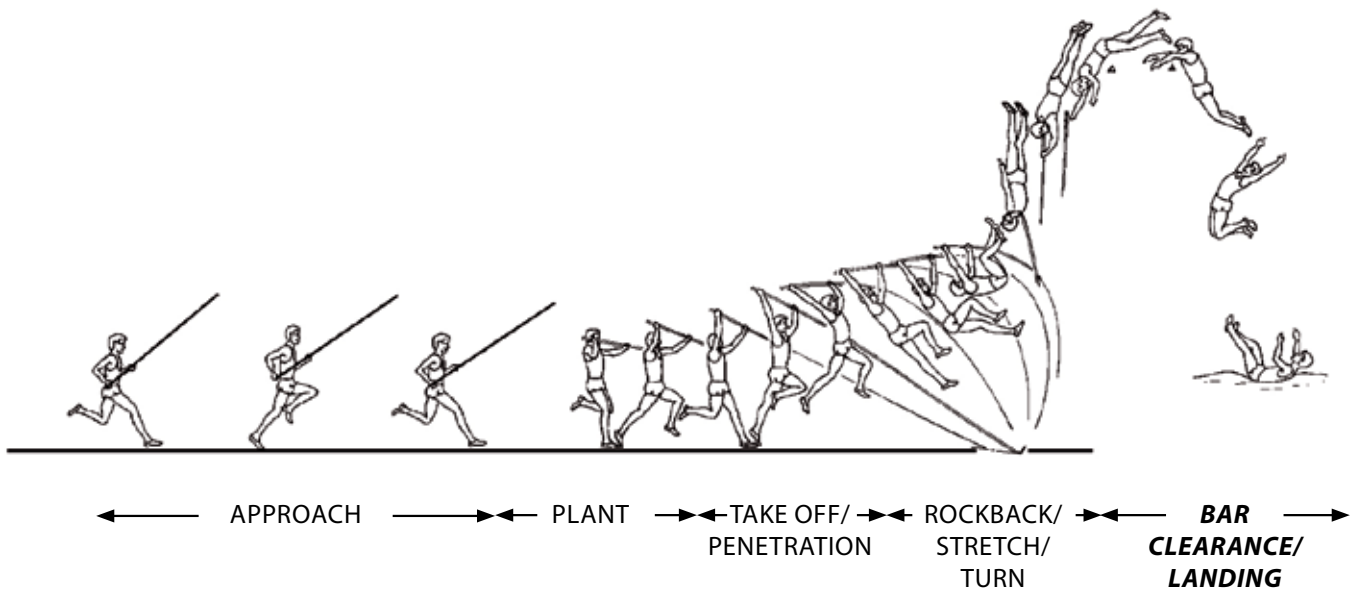

# BAR CLEARANCE/LANDING PHASE

## *Bar Clearance*



### COACHES SHOULD:

- Ensure that the landing area is safe and maintain safety during the session.
- Observe the position of the head and legs prior to landing and the actions at landing.

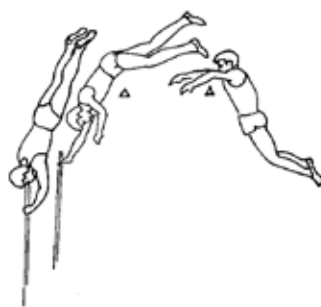

## Objective

To gain maximum height after the release of the pole and clear the bar.

## Technical characteristics

- Push-off from the pole is with the right arm.
- Bar is crossed in an arched (1) or bent (2) position.
- Body is straightened after crossing the bar.
- Landing is on the back.

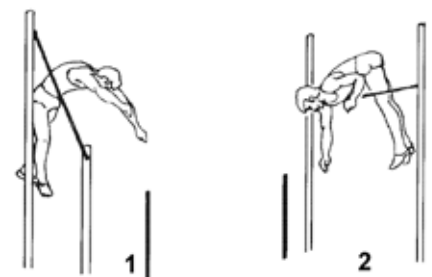

### HELP ATHLETES TO:

- Position in the air to land on the back.
- Relax at landing.
- Enjoy a safe environment.

## STEP 1 GRIP AND CARRY THE POLE

### OBJECTIVES:

To get used to holding and running with the pole.

- Place right hand close to the top of the pole.
- Place left hand about 50 cm down the pole.
- Keep right hand close to the hip.
- Start with walking.
- Proceed to easy running and sprinting.



### TIPS:

- Use pole vault poles or some other pole of similar length and weight.
- Be aware of others on the track or in the field during practice.
- Look ahead and keep the pole stable during the run.

## STEP 2 STEPS INTO SWING

### OBJECTIVES:

To feel the hang and the carry function of the pole.

### TIPS:

- On a vertical pole, extend the upper arm and then place hand on pole 30-40cms above this height.
- Keep your hand above take off foot at take off.
- Keep the grip firm not tense.
- Feel the swing on the pole.



- Hold pole above the head.
- Use three stride approach (l – r – l).
- Take off from left foot (right handed vaulters).
- Drive free leg forwards and upwards.
- Pass the pole on the right side.
- Land on left or both feet without turning.

## STEP 3 STEP INTO SWING FROM A PLATFORM

### OBJECTIVES:

To increase the 'hang' time and develop confidence in landing safely

- Set up a platform 15cm-35cm high.
- Use sand pit if no suitable pit.
- Stand upright and grip pole with extended upper arm.
- Drive free leg forward to swing off platform.
- Do not turn in the air.
- Land sitting on mat or on feet if sand pit.

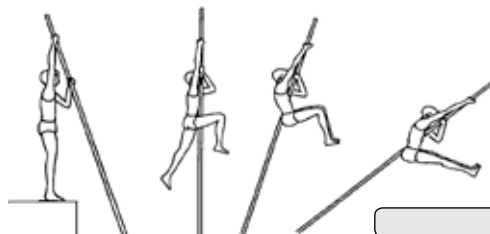

### TIPS:

- Adjust position of platform so you land in middle of mat or pit.
- Take off and bring take off leg parallel to free leg.
- Feel the swing on the pole.

## STEP 4 SWING AND TURN FROM A PLATFORM

### OBJECTIVES:

To practise the swing and turn with assisted take off.

- Set up a platform 15cm-35cm high.
- Stand upright - grip pole with extended arm.
- Drive free leg forward to swing off platform.
- Swing and turn in the second half.
- Land on both feet, face take off point.
- Vault over a low height.

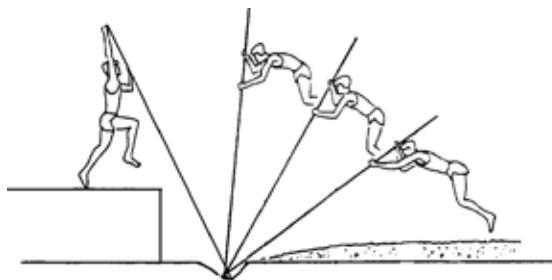

### TIPS:

- Adjust position of platform so you land in middle pit.
- Take off, 'wait', then turn.
- Feel the swing on the pole.

## STEP 5 PLANT AND VAULT

### OBJECTIVES:

To introduce the regular plant and to experience clearing the bar.



### TIPS:

- Don't rush the action.
- Let the swing action develop naturally.
- Relax into the landing.

- Practise the pole plant.
- Plant the pole first from walking then from jogging.
- Use a 5-7 stride approach.
- Take off, swing and turn.
- Land on both feet.

## STEP 6 WHOLE SEQUENCE

### OBJECTIVES:

To practise the complete movement with increasing speed.



- Carry the pole as per normal and plant.
- Start with a 'medium' approach length.
- Gradually increase approach length and speed.

### TIPS:

- Accelerate into the plant and take off.
- Focus ahead and don't collapse onto the pole.
- Think of one smooth action and rhythm through the vault.





# THROW!

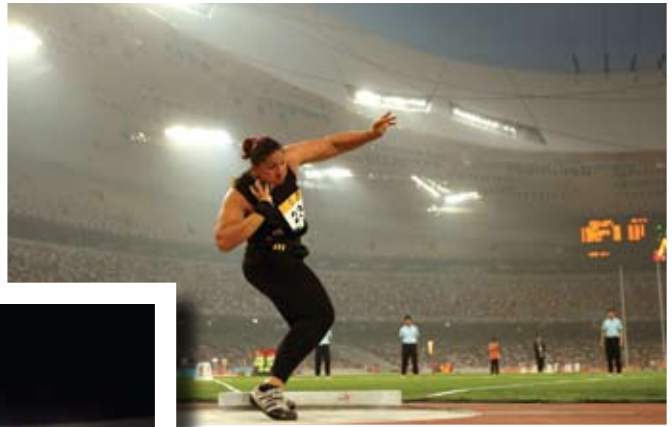

# FUNDAMENTALS OF THROWING

## 1. INTRODUCTION

Each of the events has a specific set of restrictions including (a) the characteristics of the implement used (size, weight, shape and aerodynamic qualities), (b) space limitations (the Shot Put ring, the length of the Javelin Throw runway, the throw sector lines) and (c) technique requirements dictated by the rules which influence the sequence of movements and make them unique. However, there are a number of very important commonalities among the different throws, the understanding of which will help the coach working with athletes in any of the events.

### Aims

The goal in the throwing events is to maximize the measured distance covered by the implement.

### Biomechanical Aspects

The distance that any thrown object travels is determined by a number of parameters. For the athlete and coach the most important are the three release parameters: (a) **height** (b) **speed** and (c) **angle** and, in the cases of the Discus Throw and Javelin Throw, the (d) **aerodynamic qualities of the implement** and (e) **environmental factors** (wind and air density due to relative humidity and or altitude).

The release height is determined by the athlete's body height though it is influenced by the athlete's position at release. The release velocity and release angle are both the result of the actions of the athlete prior to and during release. Neither the aerodynamic qualities of the implement nor the environmental factors can be affected by the athlete, though it is possible to make some adjustments to the throwing technique that will maximise the potential distance of a throw.

### Movement Structure

The movements of the throwing events can be broken down into four main phases:

1. **Preparation**
2. **Momentum building**
3. **Delivery**
4. **Recovery.**

**Note:** The descriptions below apply to right-handed throwers.

In the preparation phase the athlete grips the implement and assumes a position to start the momentum building phase. The preparation has no direct influence on the throwing distance.

In the momentum building phase the athlete and implement initially move together as one unit but then the athlete overtakes the implement during the 'hop' or impulse stage in the javelin, the glide in the linear shot put, the turn in the discus and the rotational shot put and during the single support phase of the hammer turns.

In the delivery phase velocity is stored, increased and transferred from the athlete's body to the implement and the implement is released. The link between the momentum building phase and the delivery phase is the **power position**, when the athlete has two feet on the ground. With some differences for the Hammer Throw, the common features of an effective power position in the throwing events are:

- Muscular tension throughout the body.
- A balanced stance with both feet on the ground.

- Body weight over the right foot, right heel lifted.
- Right heel and left toe lined up.
- Backward lean against the direction of the throw.

In addition to an effective power position the common elements of effective delivery phases are:

- A well co-ordinated sequence of successive action of all the joints involved in the throw: foot, knee, hip, shoulder, arm and hand.
- A twisting extension of the right leg using the strong muscles of the leg to lift the body.
- A bracing of the left leg to accelerate the right side of the body and produce vertical movement.
- A bow tension or twisted position causing high pretension in the trunk, shoulder and arms which can be used to produce acceleration.
- A blocking action in the upper body in which turning movement of the trunk is stopped with the left side allowing the right side to accelerate.

In the recovery phase the athlete braces against any remaining velocity and avoids fouling.

## 2. TEACHING THROWING TECHNIQUE

The chaining method is usually used to teach the throwing events. Concentration should be on the following elements in the order given:

- Introduction to the implement (safety and grip)
- Delivery (using front throws)
- Power Position
- Delivery
- Recovery
- Momentum Building
- Preparation Phase

### Points to Emphasise:

- Optimum speed in the preparation and building momentum phases in the momentum building phase.
- Increasing acceleration in all phases – finishing as fast as controllable in the delivery.
- Effective and stable power position.
- Successive sequencing of body movements starting from ground level and moving up through the body finishing with maximum speed being transferred to the implement.
- Complete extension of the body in the delivery.
- Developing technique with implements slightly lighter than competition weight.
- A wide variety of exercises, implements, throwing movements and situations.

### Points to Avoid:

- Introduction of competition technique to young or beginner athletes who have not reached the appropriate physical stage of development.
- Implements of inappropriate size, weight or aerodynamic qualities.
- Introduction of new technique elements before satisfactory performance of those already learnt.
- Excessive throwing movements for athletes who have not gained the appropriate strength levels in the abdominal and leg muscles.



### 3. SKILL AND CONDITIONING EXERCISES

Note: Many exercises described in the 'Fundamentals of Running' and 'Fundamentals of Jumping' are also useful for throwers.

#### EXERCISE GROUP 1: WHIPPING ACTION (JAVELIN THROW)

##### One-handed throws with lighter implements

Variations:

- from standing position
- from knee stand
- with 3-stride rhythm
- with 5-stride rhythm



##### Two-handed throws with heavier implements

Variations:

- throw-ins
- from sitting position
- from knee stand
- with 3-stride rhythm

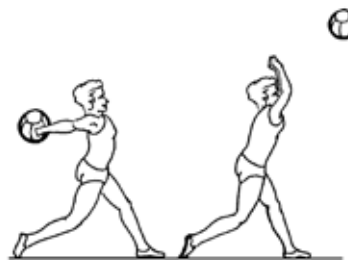

##### Loading:

Exercise	Weight	Effect	Repetitions	Sets
Standing Throw one handed	1.5-3.0 kg	Strength	5-10	2-4
3-step rhythm one handed throws	1.0-2.0 kg	Strength	5-10	2-4
Standing Throw two handed	2.0-5.0 kg	Strength	5-30	3-5
3-step rhythm two handed throws	2.0-5.0 kg	Strength	5-30	3-5
Standing Throw one handed	200-750gr	Speed	5-10	2-4
3-step rhythm one handed throws	200-750gr	Speed	5-10	2-4

## EXERCISE GROUP 2: PUTTING ACTION (SHOT PUT)

### Forward and backward overhead throw

#### Variations:

- from turning movement  
(see backward slinging action)
- with different implements:  
medicine balls, stones, shots

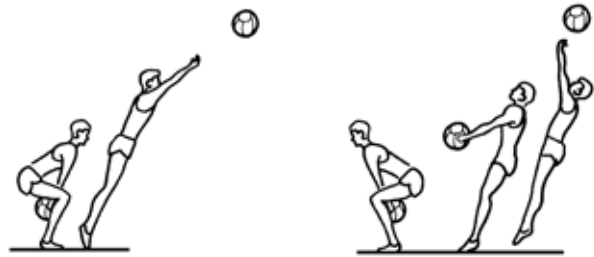

### Standing put

#### Variations:

- chest-pass
- with glide
- with two steps(left-right-left)
- from turning movement



#### Loading:

Exercise	Weight	Effect	Repetitions	Sets
Forward/backward overhead throw	3.0-4.0 kg	Strength	5-10	2-4
Standing put / with glide/steps	5.0-8.0 kg	Strength	5-10	2-4
Standing put / with glide/steps	2.0-6.0 kg	Speed	5-10	2-4

## EXERCISE GROUP 3: SLINGING ACTION (DISCUS THROW)



### Throws with light weights



### Throws with heavier weights

#### Variations:

- sitting position
- knee stand
- frontal position (see above on the right)
- power position (see above on the left)
- one-turn throw
- 1½ turns
- with different implements:  
light: sticks, rings, cones, light shots, light stones, disks  
heavy: heavy medicine balls, stones, shots, disks

#### Loading:

Exercise	Weight	Effect	Repetitions	Sets
Exercises with light implements	0.8-1.5 kg	Speed	5-10	2-4
Exercises with heavy implements	1.5-3.0 kg	Strength	5-30	3-5

## EXERCISE GROUP 4: BACKWARD SLINGING ACTION (Hammer Throw)

### Two handed backward throw over shoulder

Variations:

- lighter implements
- heavier implements
- shorter implements
- with preliminary swings, no turn
- with preliminary swings and turn
- with different implements: medicine balls, stones, hammers

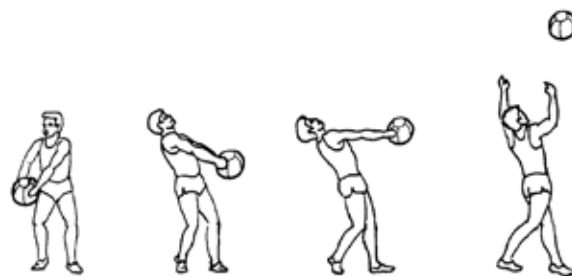

### Squat extension jumps

Variations:

- throws for height
- throws for distance



### Loading:

Exercise	Weight	Effect	Repetitions	Sets
Exercises with light implements	2.0-6.0 kg	Speed	5-10	2-4
Exercises with heavy implements	5.0-12.5kg	Strength	5-10	2-4

## 4. GAMES

### GAMES TO INTRODUCE THE JAVELIN THROW

#### “Throwing and sprinting”:

Athletes sprint with boxes to set up the targets, then return to the throwing line. After the targets are knocked down they sprint to collect the boxes.

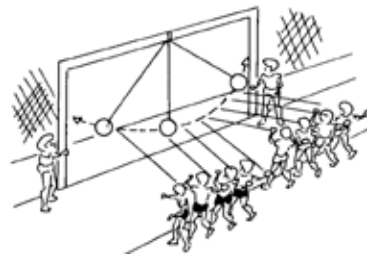
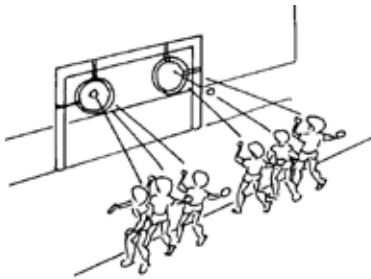
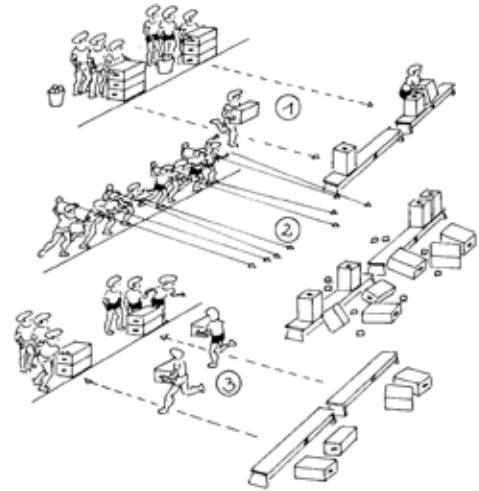

#### “Hit the targets”:

Athletes aim at bicycle tyre hung in the top corners of a football goal or at a ball swinging from the crossbar.

### GAMES TO INTRODUCE THE SHOT PUT

#### “Ball over the cord”

Athletes throw a medicine ball back and forth over a goal, a fence, a cord or a net. The aim is to put the ball on to the ground inside the other team’s area. compete to make the most throws in a set time period.

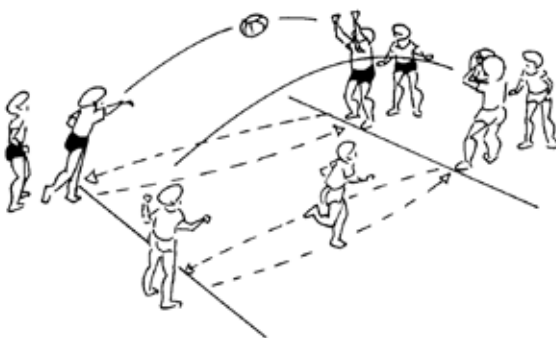
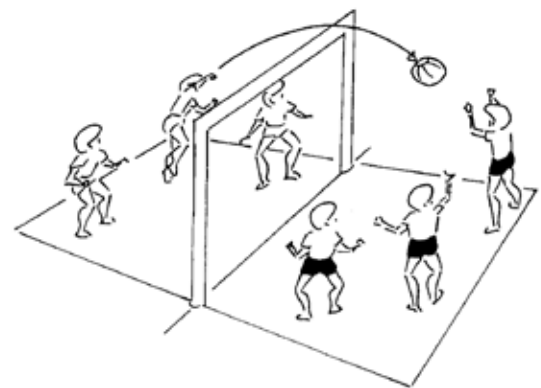

#### “Follow the ball”:

Each athlete throws or puts a medicine ball to an athlete at other end of throwing area then runs after the ball. Teams of three

## GAMES TO INTRODUCE THE DISCUS THROW

### “Throwing hoops/rings around flagpole”

Athletes throw rings or hoops at a small flag pole, trying to land exactly over it.

A round is finished when one team has achieved a certain number of “hits” or when the teams have thrown all their hoops.

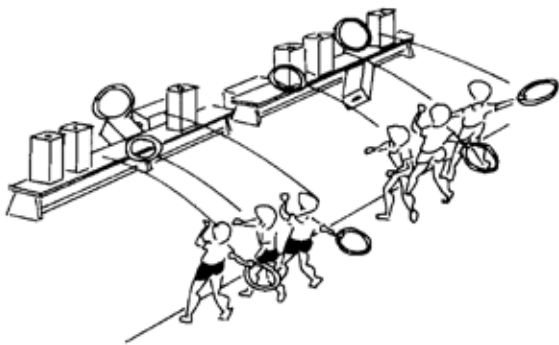
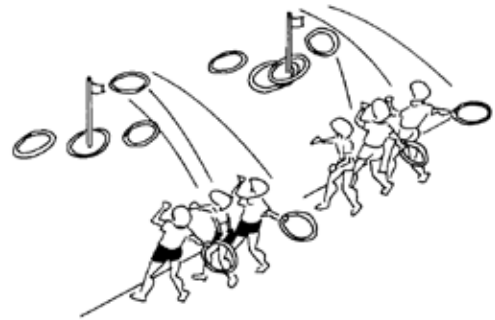

### “Knocking down cardboard boxes”

Athletes throw rings or hoops at a row of cardboard boxes. A round is finished when one team has knocked down its boxes or when the teams have thrown all their hoops.

## 5. SAFETY AND ORGANISATION

- Equipment should be kept in good repair and stored in a safe place. Test the safety of any improvised equipment before teaching.
- Throwing implements should not be used on the way to or from the throwing area and should be carried safely, javelins must be carried vertically.
- Initially all training should be under the direction of the coach.
- All throwers should stand well back from the throw line when they are waiting their turn.
- The thrower should make sure there is no one in the landing area or probable line of flight of the implement before the throw is made.
- After throwing, the thrower should wait until they have thrown or instructed to collect the implement by the coach.
- Wet conditions increase the chances of accidents and extra caution should be taken, particularly for implements sliding after landing.
- The athletes should keep in ‘eye-contact’ with the coach.
- Left handed thrower should be placed to left and right handed thrower to the right side of a group.
- Use specific organisation forms (see next page).

## ORGANISATION OF GROUPS FOR THROWING PRACTICE

- (1) Can be used for Shot Put (Linear Technique) and Javelin Throw

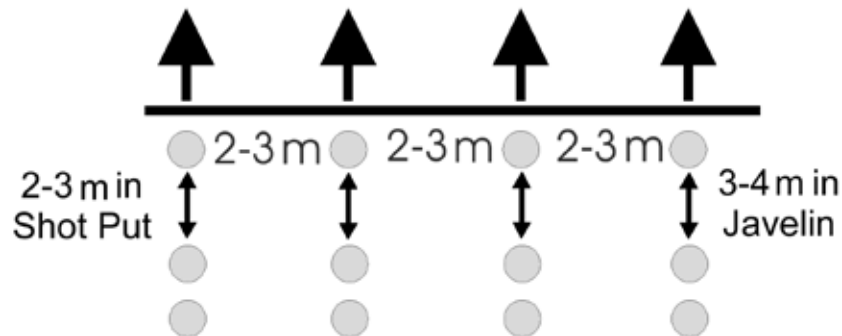

- (2) Can be used for Shot Put (Rotational Technique), Discus Throw and Hammer Throw

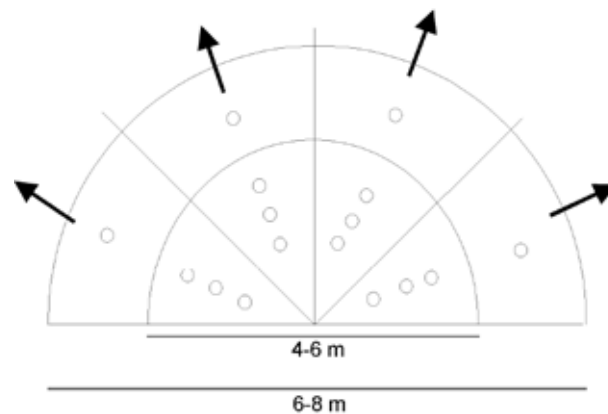

- (3) Useful for linear throwing events

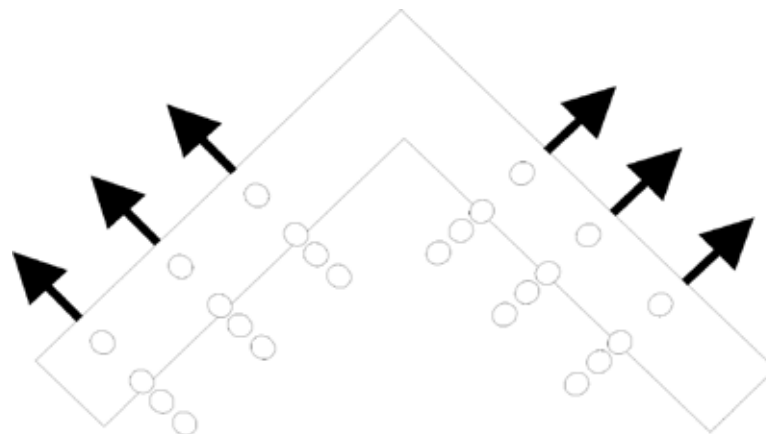

# JAVELIN THROW







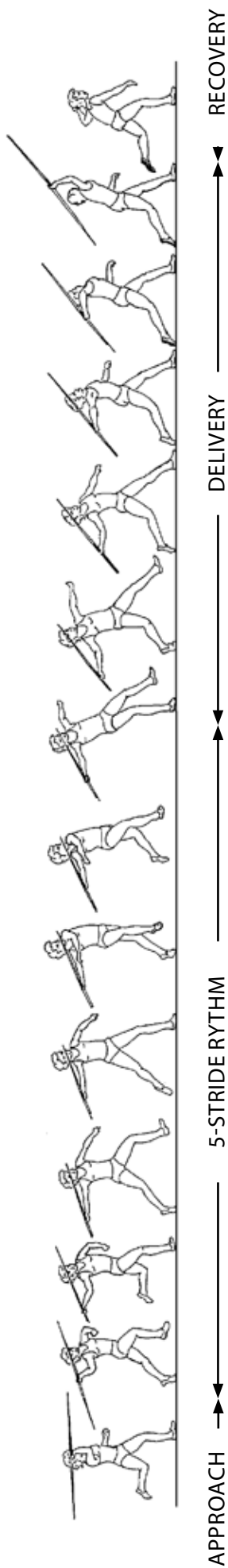

# Javelin Throw – Whole Sequence



## Phase Description

The javelin throw is divided into the following phases: APPROACH, 5-STRIDE RHYTHM, DELIVERY (which is part of the 5-stride rhythm) and RECOVERY.

- In the approach phase the thrower and javelin are accelerated.
- In the 5-stride rhythm phase they are accelerated further as the thrower prepares for the delivery phase.
- In the delivery phase additional velocity is produced and transferred to the javelin before it is released.
- In the recovery phase the thrower braces and avoids fouling.

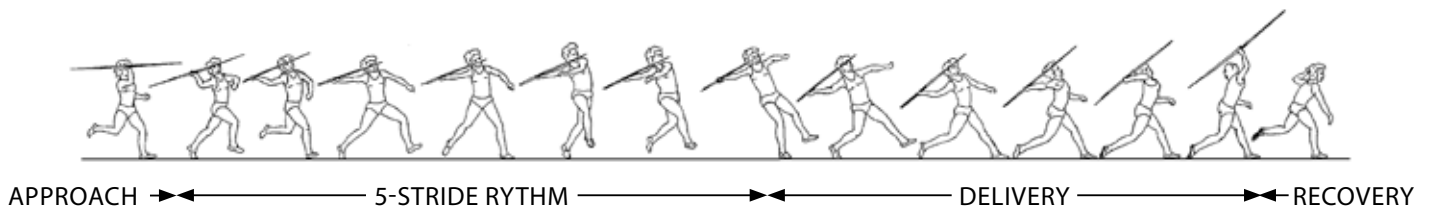

## GRIP



## Objective

To grasp the javelin firmly and comfortably.

## Technical characteristics

- Thumb and first finger grip (1), or
- Thumb and second finger grip. (2)
- Javelin lays diagonally in the hand.
- Palm faces upward.
- Grip hand is relaxed.

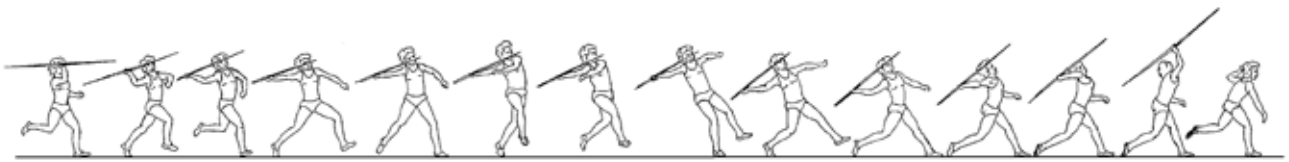

APPROACH → ← 5-STRIDE RHYTHM → ← DELIVERY → ← RECOVERY

# APPROACH PHASE



### COACHES SHOULD:

- Create and maintain a SAFE environment.
- Allow enough time for athlete to experiment with various grips.
- Observe the acceleration through the phase, the carry of the javelin and the relaxation of the athlete



## Objective

To accelerate the thrower and javelin.

## Technical characteristics

- Javelin is held horizontally over the shoulder.
- Top of the javelin is at head height.
- Arm is held steady (no forward or backward movement).
- Acceleration run is relaxed, controlled and rhythmic (6-12 strides).
- Acceleration to optimum speed, which is maintained or increased in the 5-stride rhythm.

### HELP ATHLETES TO:

- Determine the preferred grip.
- Determine the optimal length of approach.
- Run naturally while carrying the javelin.

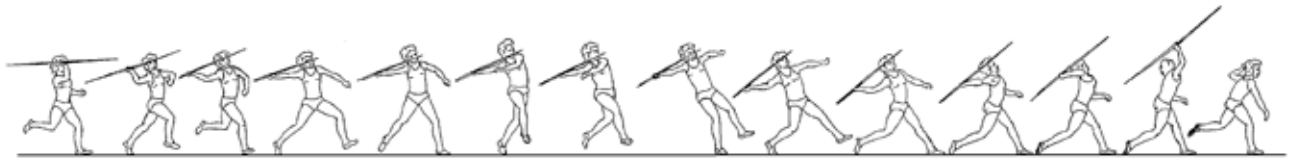

APPROACH → ← **5-STRIDE RHYTHM** → ← DELIVERY → ← RECOVERY

## 5-STRIDE RHYTHM PHASE

### *Withdrawal*

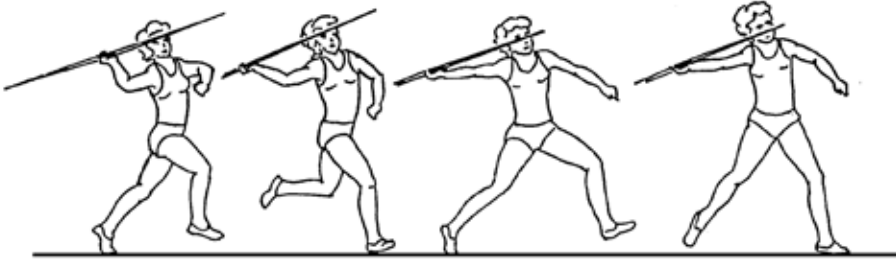

## Objective

To position the javelin correctly for the delivery.

## Technical characteristics

- Withdrawal starts on landing of the left foot.
- Left shoulder faces the direction of the throw, the left arm is held forward for balance.
- Throwing arm extends backwards during first and second strides.
- Throwing arm is at shoulder height or slightly higher after withdrawal.
- -Tip of the javelin is close to the head.

### COACHES SHOULD:

- Observe the rhythm of the 5 strides.
- Observe the limb positions and the extension of the right arm.
- Ensure that velocity is maintained through the phase.

### HELP ATHLETES TO:

- Develop the rhythm by acoustical as well as kinaesthetic feedback.
- Run away from the javelin rather than actively taking it back.
- Attain a straight but not 'locked' right arm.

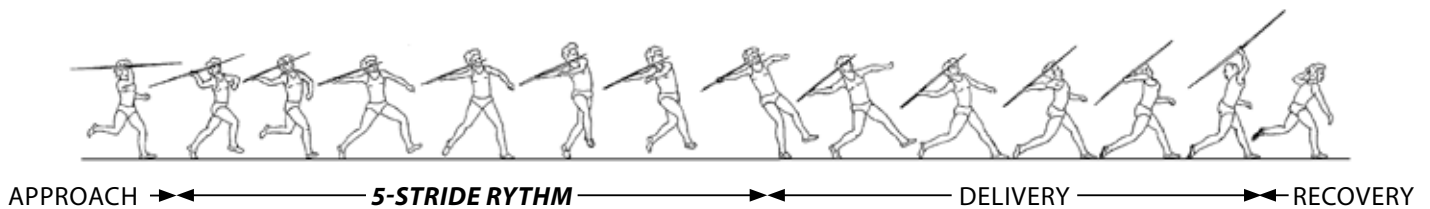

## 5-STRIDE RHYTHM PHASE

### *Impulse Stride*

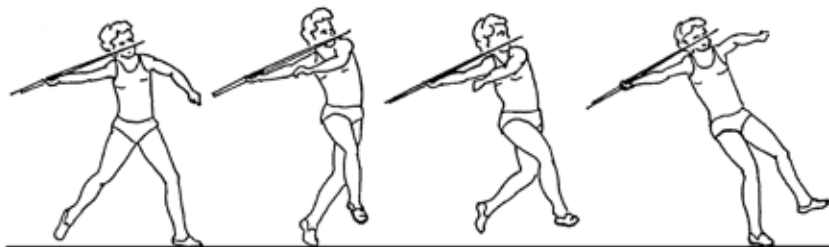

## Objective

To position and prepare the body for the delivery.

## Technical characteristics

- Drive-off is active and flat from the whole sole of the left foot (no loss of velocity!).
- Right knee swings forwards (not upwards!).
- Body leans backwards: legs and trunk 'overtake' the javelin.
- Left shoulder and head face the direction of the throw.
- Throwing arm and shoulder axis are parallel.
- Impulse stride is longer than the delivery stride.

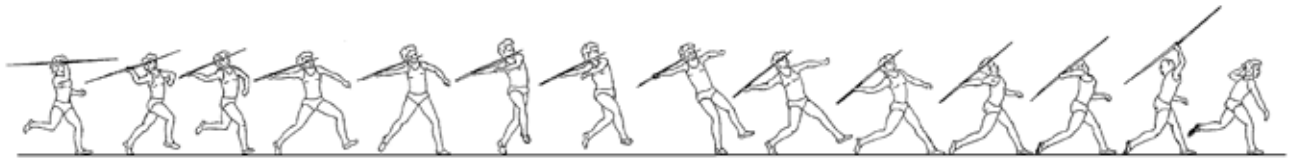

APPROACH → ← 5-STRIDE RHYTHM → ← DELIVERY → ← RECOVERY → ←

## DELIVERY PHASE

### *Part 1: Transition*



## Objectives

To transfer velocity from the legs to the trunk.

## Technical characteristics

- Right foot is placed flat at an acute angle to the direction of the throw.
- Legs have overtaken the trunk.
- Axes of the shoulder, javelin and hip are parallel.
- Right knee and hip push forwards actively.
- Throwing arm remains extended.

### COACHES SHOULD:

- Observe from the side and rear.
- Ensure that the right elbow is taken through high to prevent injury.
- Observe the limb and trunk positions through the phase.

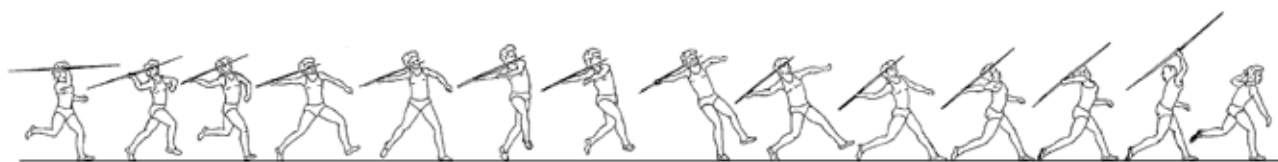

APPROACH → 5-STRIDE RHYTHM → DELIVERY → RECOVERY

# DELIVERY PHASE

## *Part 2: Power Position*

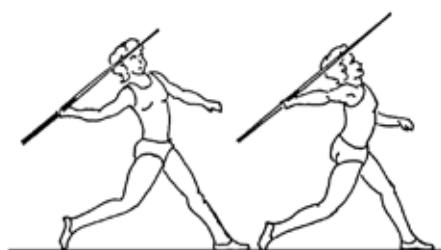

Power Position

Arc Position

## Objectives

To transfer velocity from the trunk to the shoulder and arm.

## Technical characteristics

- Placement of left foot is active and solid.
- Left side is stabilised.
- Trunk is raised and there is a turning movement around the left leg.
- Muscles in the front of the body are highly pre-tensed in the 'Arc Position'.
- Throwing shoulder pushes forwards.
- Throwing elbow turns inwards, palm remains up.

### HELP ATHLETES TO:

- Develop the strength and flexibility needed for the braced arc throwing position.
- Pull through the javelin.
- Feel the 'whipping through' of the throwing arm.
- Keep the right foot grounded and dragged through the delivery and release.

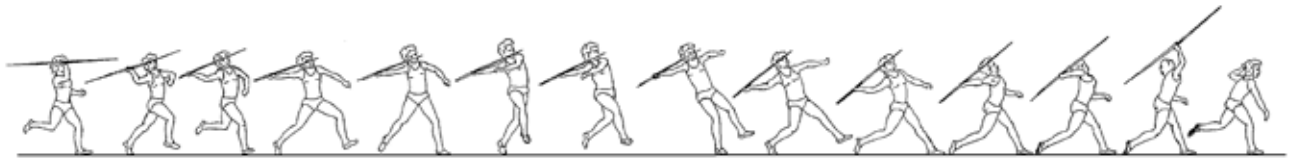

APPROACH → 5-STRIDE RHYTHM → DELIVERY → RECOVERY

## DELIVERY PHASE

### *Part 3: Final Arm Movement*

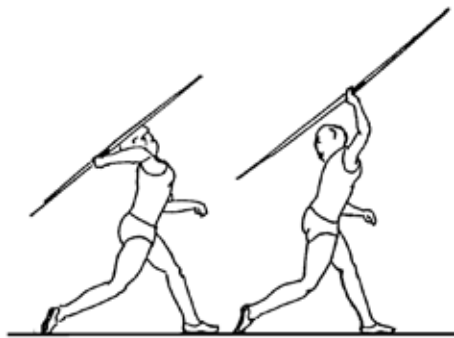

## Objective

To transfer velocity from the shoulder and arm to the javelin.

## Technical characteristics

- Right elbow draws forwards and upwards alongside the head.
- Trunk moves forwards.
- Throwing elbow straightens explosively.
- Left side of the body is blocked by a solid left leg and the fixing of the bent left elbow close to the trunk.
- Right foot maintains ground contact until the javelin is released.



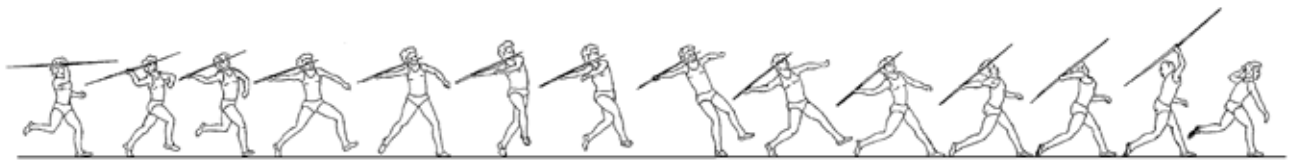

APPROACH → ← 5-STRIDE RHYTHM → ← DELIVERY → ← RECOVERY

# DELIVERY PHASE

## Part 3: Final Arm Movement

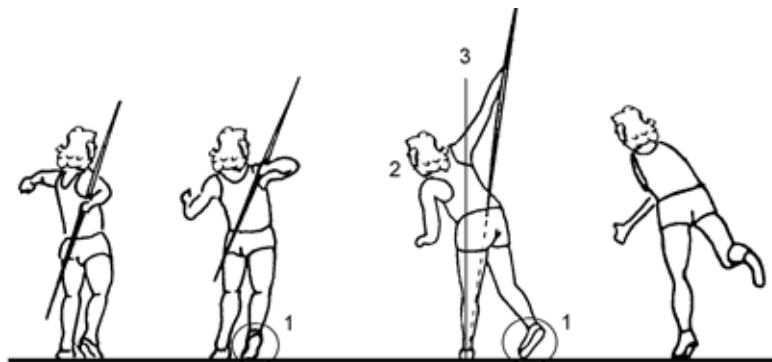
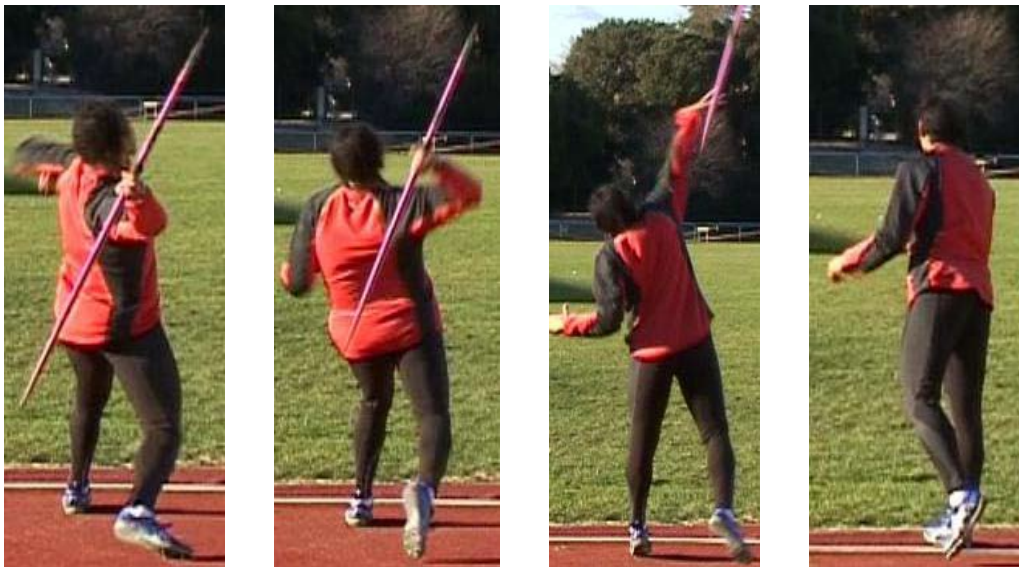

### Objectives

To transfer velocity from the shoulder and arm to the javelin.

### Technical characteristics

- Right foot turns on its outside edge and is dragged behind. (1)
- Trunk leans slightly to the left, the right shoulder is directly over the left foot. (2) (3)
- Throwing arm should be as close to vertical as possible at release. (3)

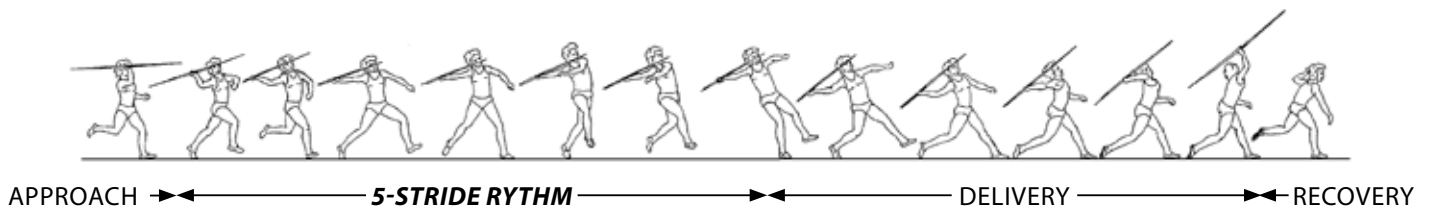

## 5-STRIDE RHYTHM PHASE

### *Foot Placement*

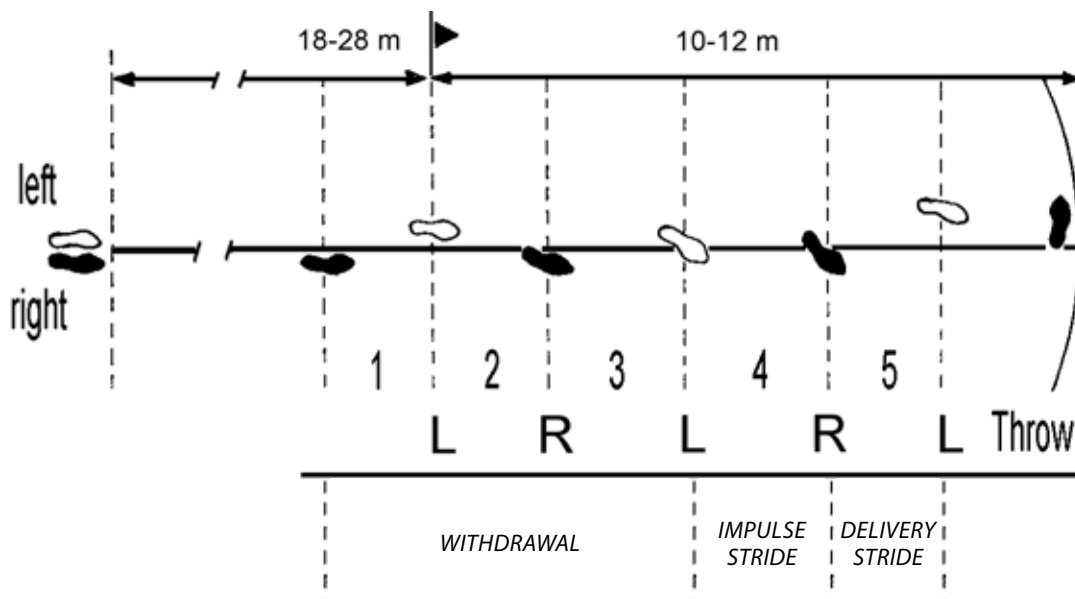

## Objective

To create velocity and transfer it to the javelin.

## Technical characteristics

- 5-stride rhythm comprises:
  - the withdrawal
  - the impulse stride
  - the delivery
- Speed increased to optimum level (based on individual capability).

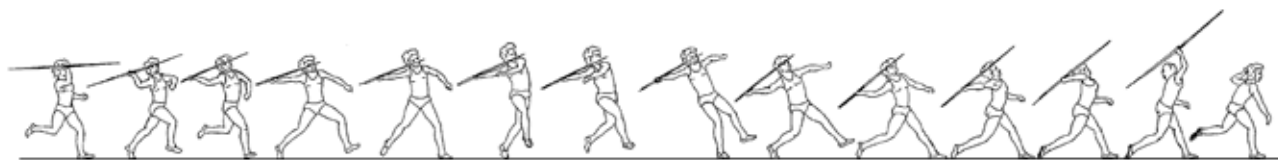

APPROACH → 5-STRIDE RHYTHM → DELIVERY → RECOVERY

# RECOVERY PHASE



### COACHES SHOULD:

- Observe the position of the left foot at release.
- Observe the actions following the release of the javelin.
- Ensure that the athlete has the correct footwear for safety

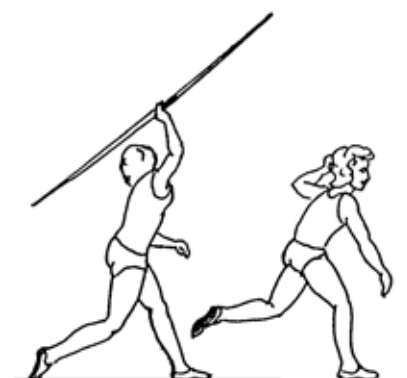

## Objectives

To stop the forward movement of the body and avoid fouling.

## Technical characteristics

- Legs are reversed quickly after the release.
- Right is leg bent.
- Upper body is lowered.
- Left leg swings backwards.
- Distance from the foot of the brace leg to the foul line is 1.5 – 2.0 m.

### HELP ATHLETES TO:

- Determine the optimal release point, which will give the overall measurement to the start of the approach.
- Be strong but relaxed through this phase.

## STEP 1 FRONT THROWS

### OBJECTIVES:

To accelerate the javelin along a straight path.

#### TIPS:

- Try both grips, decide which is the most comfortable.
- Let the javelin rest down the palm of the hand with the fingers gripping firmly but relaxed.

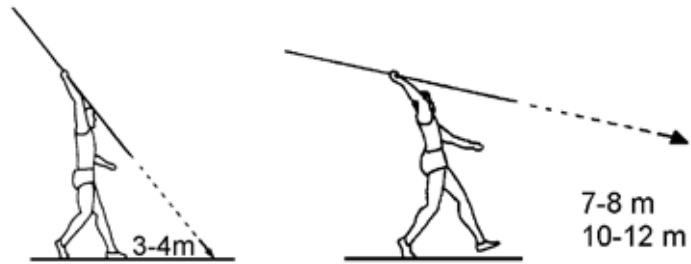

- Introduce the javelin, safety measure and grip.
- From a line, face the throwing area.
- Withdraw the javelin, holding high above the head and point the javelin to the ground.
- Lean backwards and throw the javelin to land 8m-10m away, and with the end of the javelin pointing to the thrower.

## STEP 2 STANDING THROW

### OBJECTIVES:

To throw from the power position.

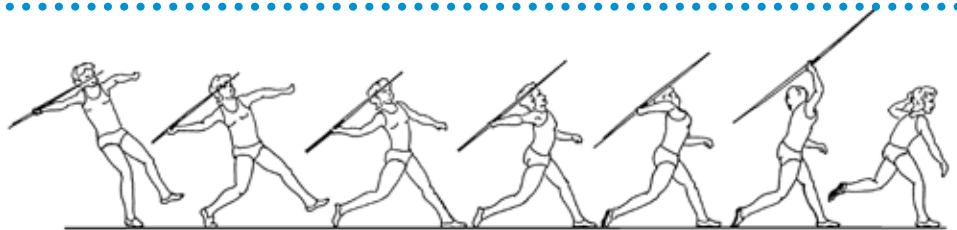

- Stand with the left foot about 60cm-90cm in front of the right with feet pointing in direction of throw.
- Withdraw the javelin keeping the palm above shoulder level.
- Lift the left leg slightly to initiate movement, keeping the weight on a bent right leg.
- Drive the right hip forward and throw.

#### TIPS:

- Emphasise relaxed effort rather than trying to throw for distance.
- Keep the left side strong.

## STEP 3 3-STRIDE RHYTHM AND THROW



#### TIPS:

- Count the rhythm 1---2/3.
- Don't let the throwing arm bend too soon.
- Keep the palm up

### OBJECTIVES:

To introduce impulse stride and link it with the power position.

- Start with the right leg forward and the javelin withdrawn.
- Step onto the whole sole of the left foot and push off into the impulse stride, with the feet landing quickly one after the other.
- Continue into the throw

## STEP 4 5 STEPS AND THROW

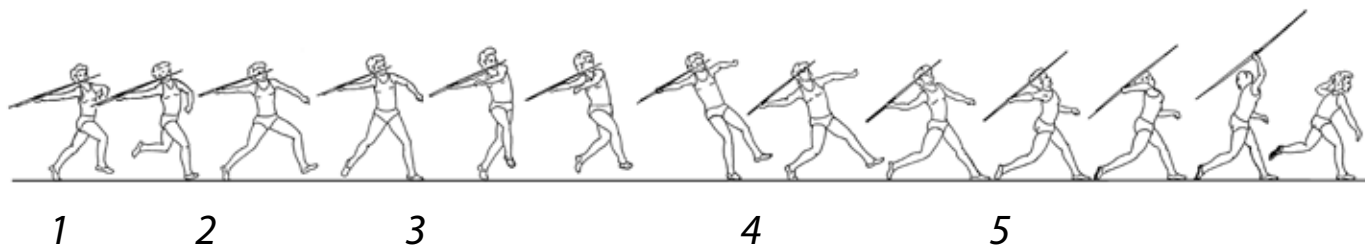

### TIPS:

- Count the rhythm:  
1--2--3-----4/5
- From the power position, “make a bow, watch it go”.
- Practice the recovery.

### OBJECTIVES:

To develop the movements of the 5-stride rhythm.

- Start with feet level and javelin withdrawn.
- First step is onto the right leg.
- Begin with 2 walking strides, later 2 running, into the 3 stride rhythm.
- Continue into the throw.

## STEP 5 APPROACH AND WITHDRAWAL



### OBJECTIVES:

To introduce withdrawal and couple approach with the 5-stride rhythm.

- Ensure a safe practice area.
- Practice withdrawal at walking then running speed.

### TIPS:

- “Walk/run away from the javelin” in the withdrawal, don’t pull it backwards.
- Javelin tip by the eye.
- Maintain running speed through the withdrawal.

## STEP 6 WHOLE SEQUENCE



### TIPS:

- Develop the speed and rhythm of the approach.
- “Throw through the line of javelin”.
- Think of the whole sequence.

### OBJECTIVES:

To link the phases into a complete movement.

- Complete sequence controlling and correcting the power position.
- Complete sequence with a light javelin.
- Complete sequence with different implements such as throwing balls or stones.



# SHOT PUT – LINEAR







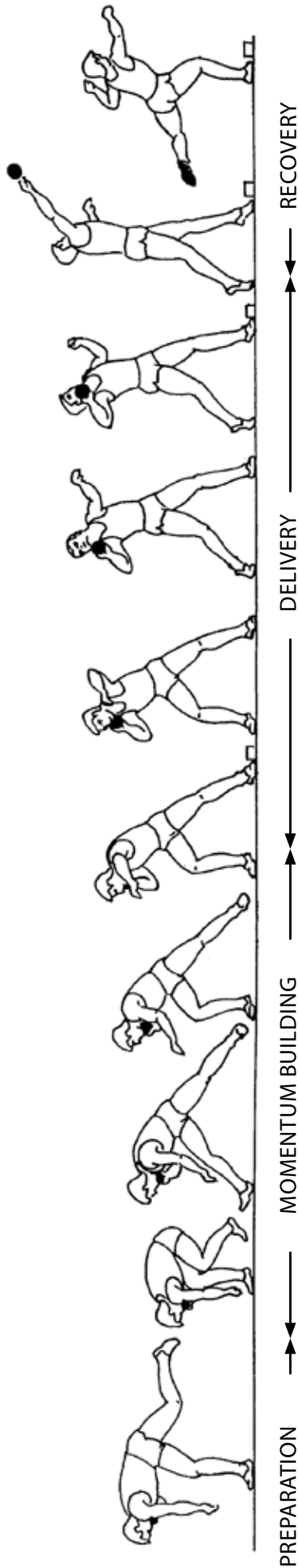

# SHOT PUT *LINEAR TECHNIQUE* – Whole Sequence

## Phase Description

The Linear Shot Put Technique is divided into the following phases: PREPARATION, MOMENTUM BUILDING, DELIVERY and RECOVERY.

- In the preparation phase the thrower is positioned for the start of the glide, the momentum building phase.
- In the momentum building phase the thrower and the shot are accelerated as the thrower prepares for the delivery phase.
- In the delivery phase additional velocity is produced and transferred to the shot before it is released.
- In the recovery phase the thrower braces and avoids fouling.



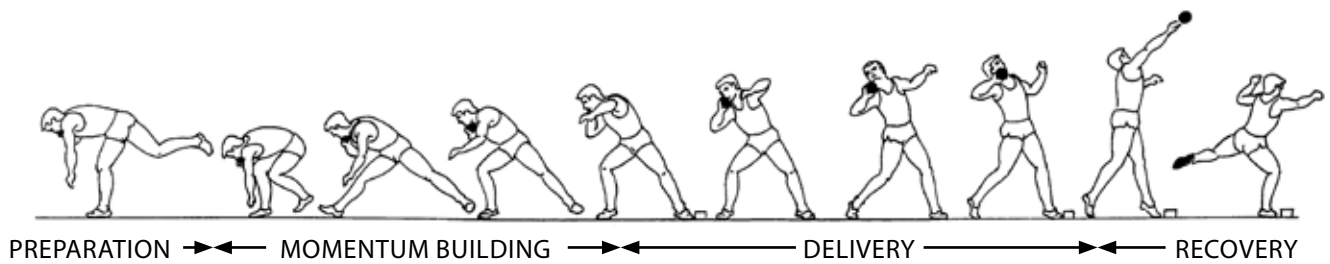

## GRIP



## Objective

---

To hold the shot firmly.

## Technical characteristics

---

- Shot rests on the fingers and the base of the fingers.
- Fingers are parallel and slightly spread.
- Shot is placed at the front part of the neck, the thumb on the collarbone.
- Elbow is out at a 45° angle to the body.

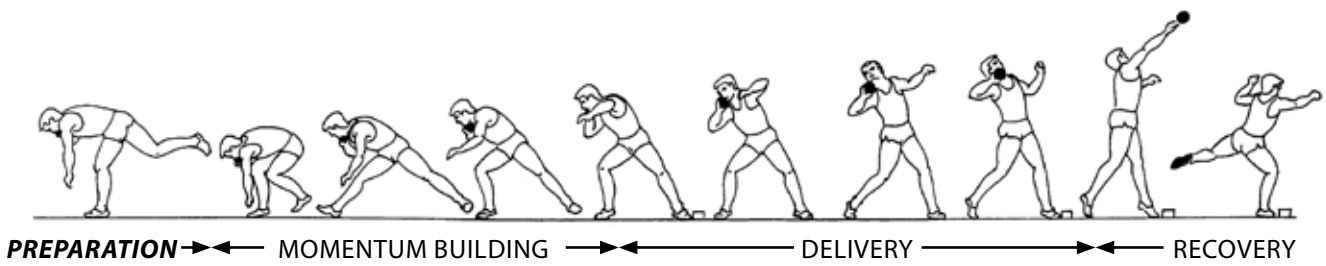

## PREPARATION PHASE



### COACHES SHOULD:

- Create and maintain a SAFE environment.
- Allow enough time for athlete to become familiar with the grip.
- Observe the body and limb positions and stability through the phase.

## Objective

To prepare for the glide.

## Technical characteristics

- Thrower starts upright at the rear of the circle with back to the stopboard.
- Trunk is bent forward parallel to the ground.
- Body is balanced in the single support.
- Support leg is bent while the free leg is drawn towards the back of the circle. (1)

### HELP ATHLETES TO:

- Look to ensure the throwing area is clear before commencing the preparation phase.
- Remember for the grip and placement, “Clean palm, dirty neck”
- Develop the balance needed for the phase.

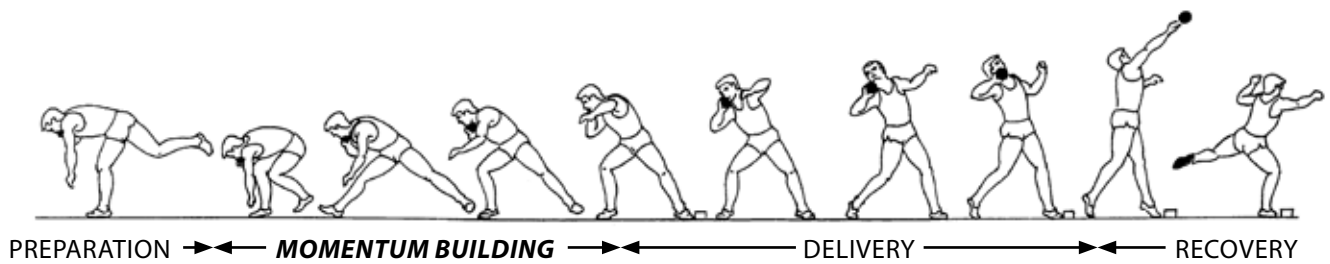

## MOMENTUM BUILDING OR GLIDE PHASE

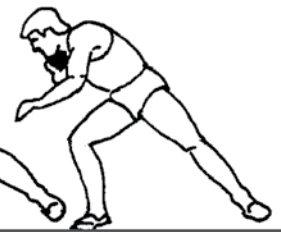
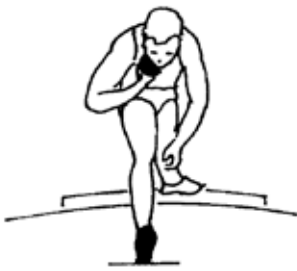

### Objective

To initiate acceleration and position the body for the final putting action.

### Technical characteristics

- Body moves from the forefoot on to the right heel, unseating the hips.
- Free leg is driven low towards the stopboard.
- Support leg extends over its heel.
- Support leg maintains ground contact through most of the glide.
- Shoulders are kept square to the rear of the circle.

#### COACHES SHOULD:

- Observe the limb positions and the extension of the left then right legs.
- Ensure that acceleration is maintained through the phase.
- Ensure a glide rather than a hop.

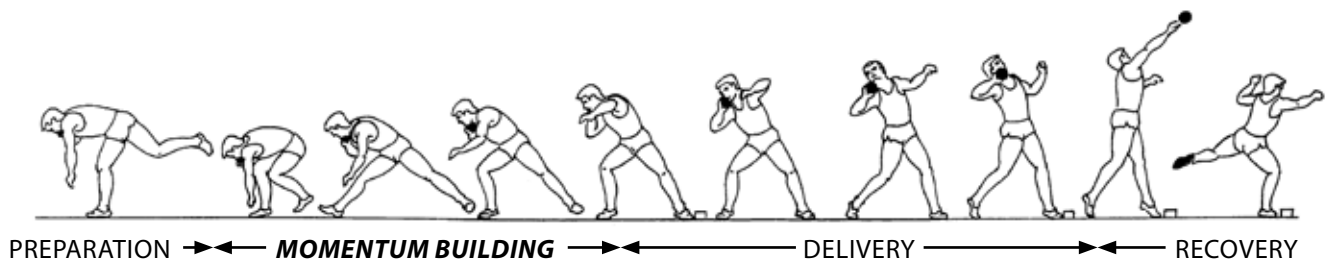

## GLIDE PHASE

### *Foot Placement*

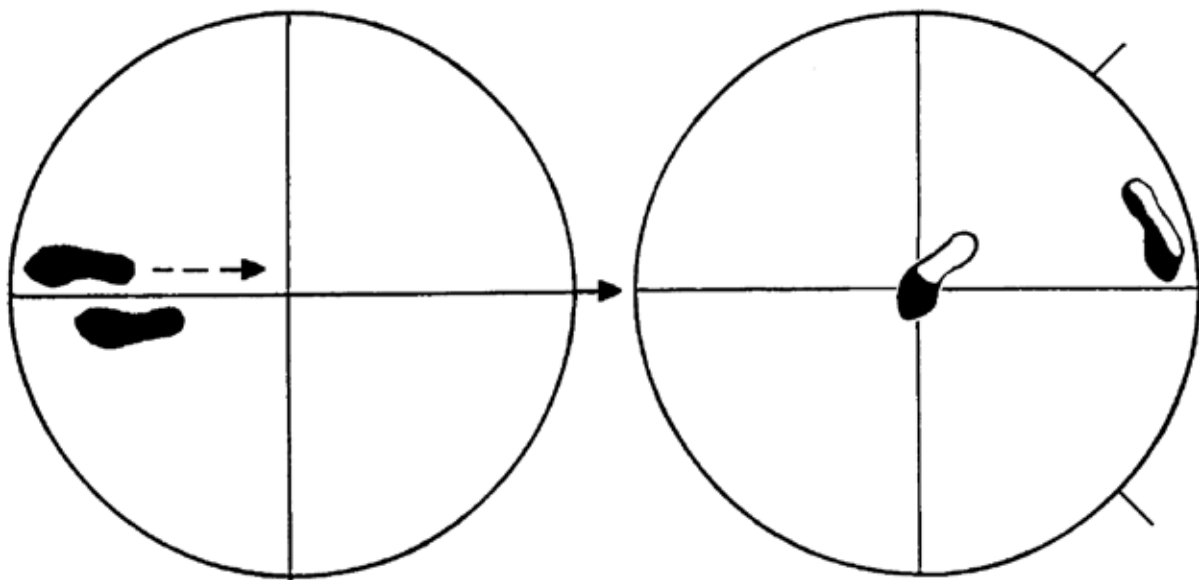

*Power Position*

## Objective

To initiate acceleration and position the body for the final putting action.

## Technical characteristics

- Right foot glides off its heel and lands on the ball of the foot.
- Right foot is placed in the centre of the circle.
- Feet land almost simultaneously, right foot first.
- Left foot lands on the ball and inside of the foot.
- The delivery phase begins when both feet land on the ground after the glide.

### HELP ATHLETES TO:

- 'Fall back' while driving off the right heel.
- Pull the right foot quickly under the body.
- Keep the shoulders facing the rear.

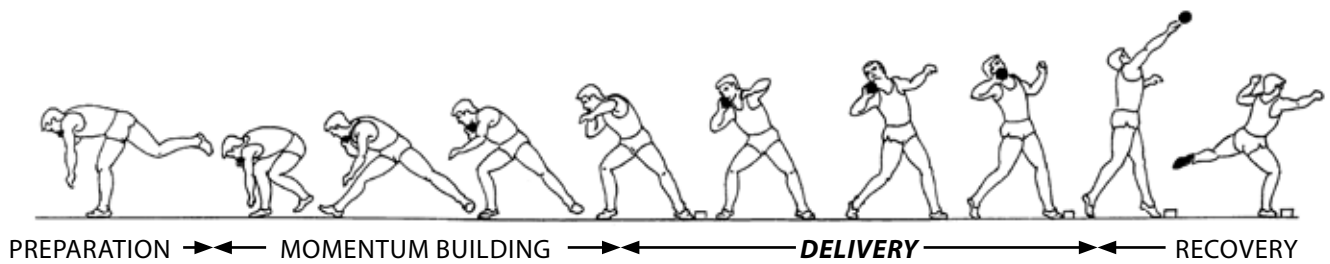

## DELIVERY PHASE

### *Part 1: Power Position*



#### HELP ATHLETES TO:

- Gain a 'chin-knee-toe' vertical alignment in the power position.
- Coordinate the correct timing of, 'big muscles before small'.
- Develop the strength for a braced left side.

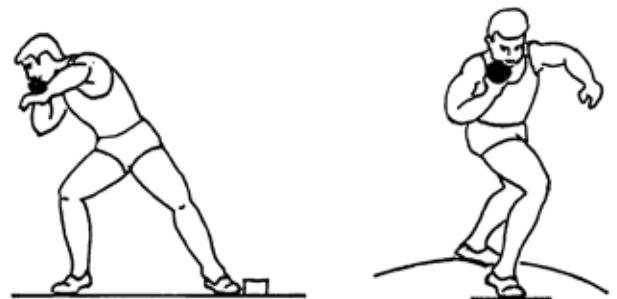

## Objective

To maintain the speed of the shot and begin its main acceleration.

## Technical characteristics

- Body weight is carried on the ball of the right foot, right knee is bent.
- Heel of the right foot and the toe of the left foot are placed in line ('Heel-Toe Position').
- Hips and shoulders are twisted.
- Head and left arm locked back.
- Right elbow is at approx. 90° angle to the trunk.

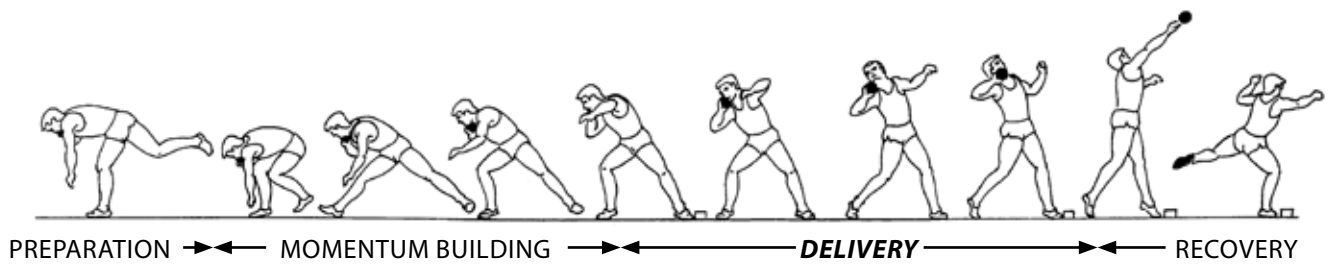

## DELIVERY PHASE

### *Part 2: Main Acceleration*

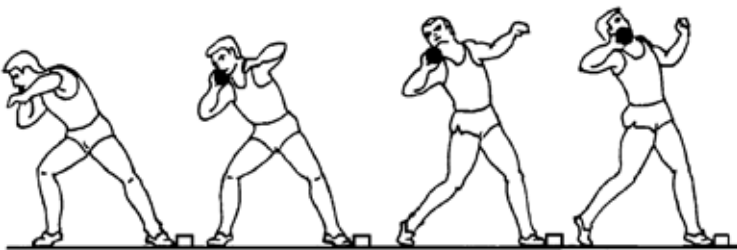

#### COACHES SHOULD:

- Observe from side and rear.
- Ensure that the right elbow is kept high.
- Observe the feet, limb and trunk positions through the phase.
- Observe angle of release.

### Objective

To transfer velocity from the thrower to the shot.

### Technical characteristics

- Right leg is extended in an explosive twisting movement until the right hip faces the front of circle.
- Left leg is almost extended and braced, lifting the body (and influencing the angle of release).
- Trunk's twisting movement is blocked by the left arm and shoulder.
- Right elbow is turned and raised in the direction of the throw.
- Body weight is transferred from the right leg to the left.

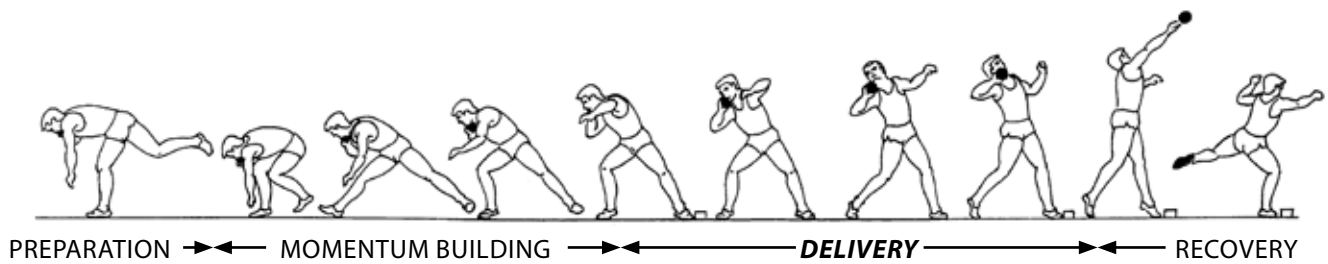

## DELIVERY PHASE

### *Part 3: Final Arm Movement*

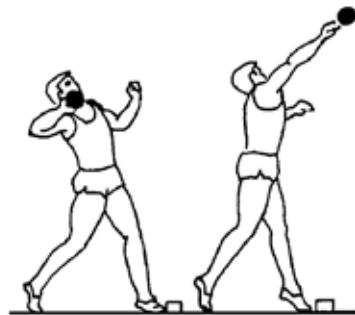

### Objective

---

To transfer velocity from the thrower to the shot.

### Technical characteristics

---

- Strike of the putting arm begins after full extension of the legs and trunk.
- Left arm is bent and fixed close to the trunk.
- Acceleration is continued by the pre-stretched wrist (thumbs down, fingers turning out after the release).
- Feet are in contact with the ground for the release.
- Head is behind the left (bracing) foot until the release.



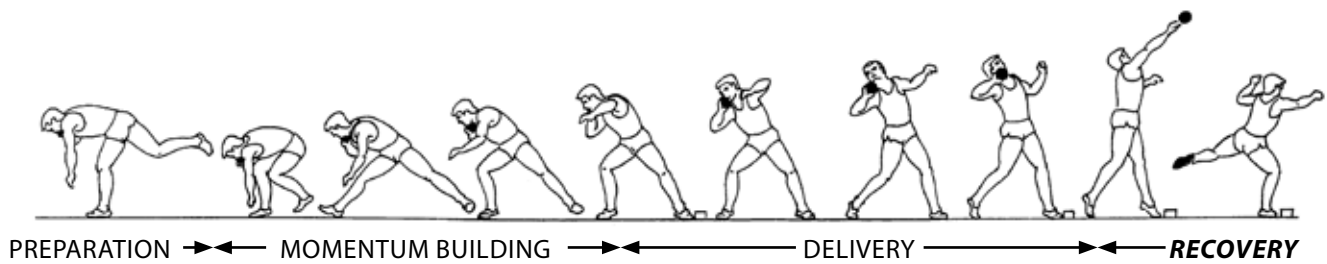

## RECOVERY PHASE

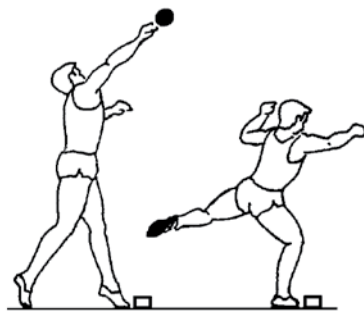

### COACHES SHOULD:

- Observe from the side and rear.
- Develop practices to time the reverse action.
- Ensure that the athlete has the correct footwear for safety.

## Objective

To stabilise the thrower and avoid fouling.

## Technical characteristics

- Legs change quickly after the release.
- The right leg is bent.
- Upper body is lowered.
- Left leg swings backwards.
- Eyes look down.

### HELP ATHLETES TO:

- Throw, then recover.
- Recover in an active, relaxed way and stay in the circle.
- Leave the rear of the circle under control.

## STEP 1 INTRODUCTION

### OBJECTIVES:

To get used to the implement and the basic putting movements.

- Introduce the shot, safety measures and grip.
- Slow extension or push upwards.
- Flicking shot with fingers. (1)
- Forward two-handed toss. (2)
- Backward overhead, two-handed toss. (3)



### TIPS:

- 'Clean palm' in the grip.
- Legs before arms.
- Slow to fast.
- Finish 'tall'.

## STEP 2 FRONT PUTS

### OBJECTIVES:

To use legs for acceleration and learn the correct arm strike.

- Stand with feet shoulder-width apart.
- Wind up with bent knees, unwind and throw.
- As for previous drill, but step forwards on to the balls of feet.
- Maintain contact with the ground.



### TIPS:

- Keep the right elbow high.
- Use an appropriate weight shot.

## STEP 3 PUT FROM A STEP

### OBJECTIVES:

To develop the activity of right leg and blocking of left side (leg and trunk).

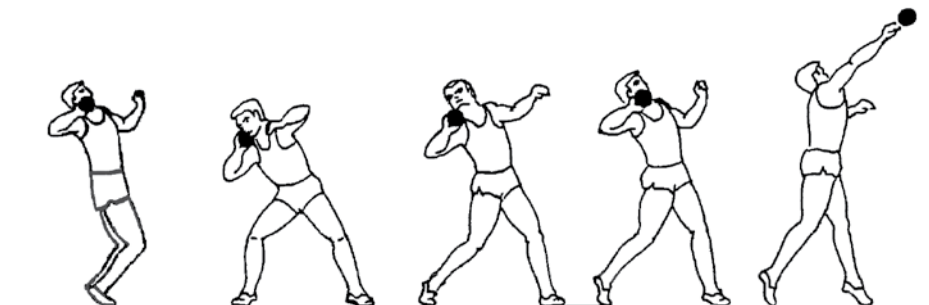

### TIPS:

- Use the legs and twisting action to initiate the throw.
- 'Block' the left side and keep left shoulder high.

- Stand with feet shoulder-width apart.
- Step backwards, turning hip and shoulder against direction of throw.
- Continue with an immediate, forwards twisting extension of the legs and hips.

## STEP 4 PUT FROM POWER POSITION

### OBJECTIVES:

To develop the activity of right leg; turn of legs, hips, trunk and blocking.

#### TIPS:

- In the power position the alignment should be 'chin-knee-toe'.
- 'Punch a hole in the sky'
- Practice the recovery.

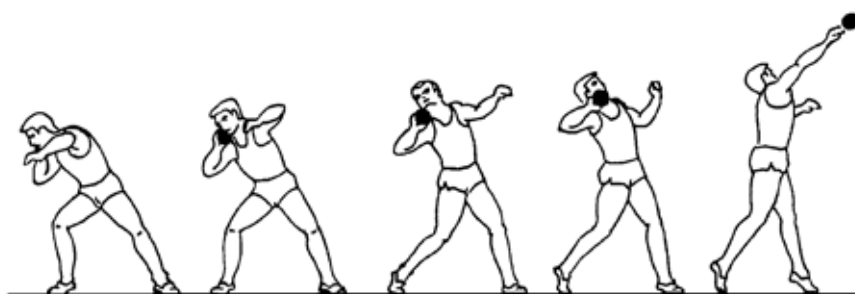

- Start with feet in the power position.
- Turn shoulders away from the direction of the throw, weight over the right foot
- Begin the put with the right leg and hip.
- Transfer weight from right to left.

## STEP 5 GLIDE

### OBJECTIVES:

To develop the glide action of the legs and link it with the delivery.

#### TIPS:

- Keep your shoulders to the rear in the glide.
- Don't hop, pull the right foot back under the body.
- Keep hips 'open' with correct right heel, left toe alignment.

- Glide with a partner holding the free arm. (1)
- Continue glide along a line, stop in power position (without/with release). (2)



(2)



## STEP 6 WHOLE SEQUENCE

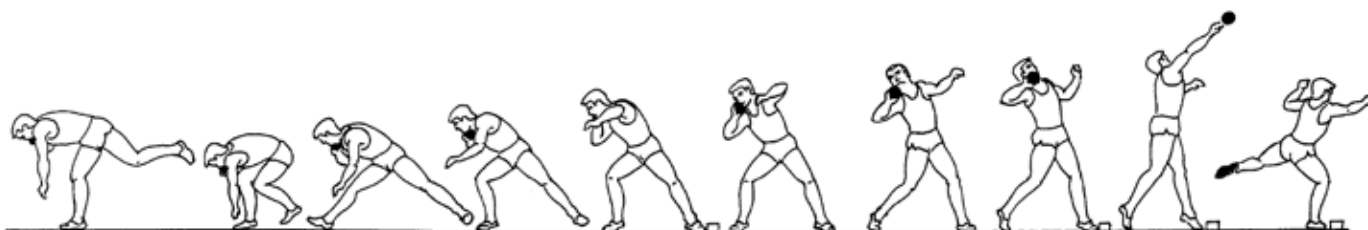

#### TIPS:

- Develop the speed and rhythm of the put.
- Be explosive through the delivery and release.
- Think of the whole sequence.

### OBJECTIVES:

To link the phases into a complete movement.

- Perform without and with the shot, controlling and correcting the power position.
- Perform on different surfaces, with eyes closed, different implements (e.g. medicine balls) and different shot weights.



# SHOT PUT – ROTATIONAL





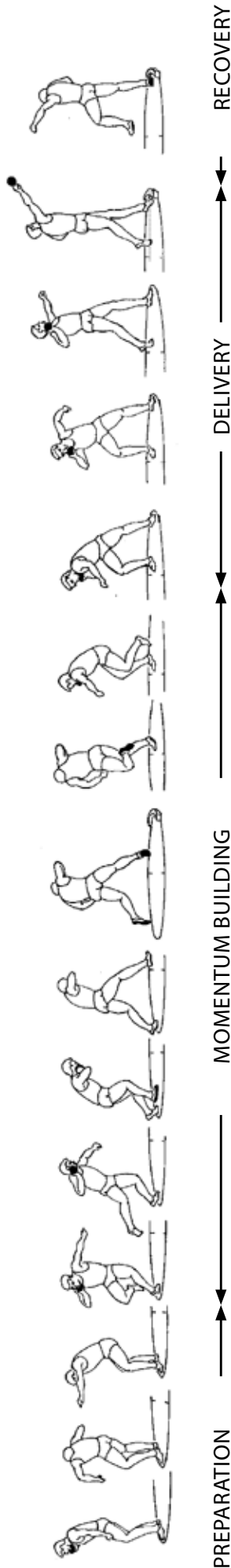

# SHOT PUT *ROTATIONAL TECHNIQUE* – Whole Sequence

## Phase Description

The Rotational Shot Put Technique is divided into four phases: PREPARATION, MOMENTUM BUILDING, DELIVERY and RECOVERY.

- In the preparation phase the thrower moves to the optimum position to begin the turn and pre-tension is built up.
- In the momentum building phase the shot is accelerated as the thrower moves to the optimum position for delivery.
- In the delivery phase additional velocity is produced and transferred to the shot before it is released.
- In the recovery phase the thrower avoids fouling.



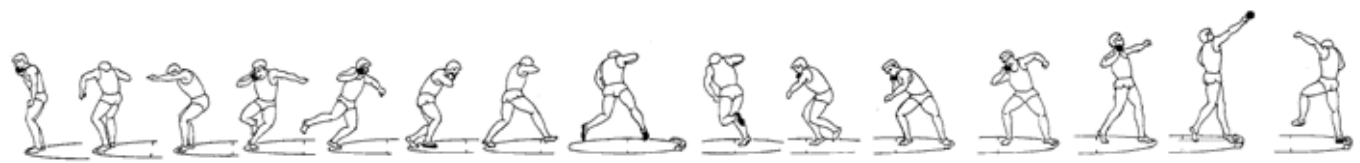

**PREPARATION** ←————— **MOMENTUM BUILDING** —————→ **DELIVERY** —————→ **RECOVERY**

## PREPARATION PHASE

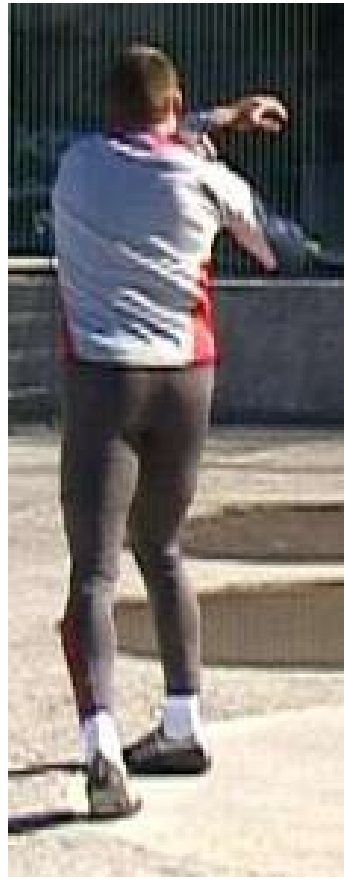

### COACHES SHOULD:

- Create and maintain a SAFE environment.
- Observe the body and limb positions, timing and stability through the phase.

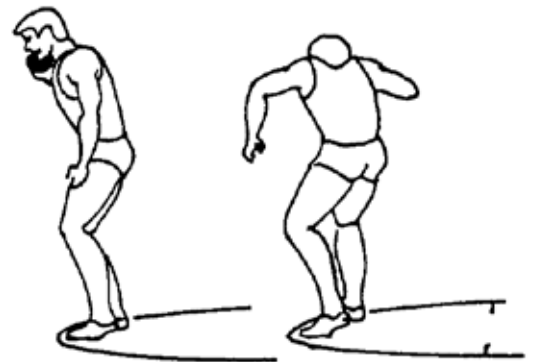

### Objective

To assume an optimum position and grip, pre-tensing the trunk in preparation for the turn.

### Technical characteristics

- Shot is placed further back on the neck than in the Linear Technique.
- Upper body is bent slightly forward with the back to the stopboard.
- Legs are spread a little more than shoulder-width.
- Weight is on the balls of the feet.
- Upper body twists against the direction of the turn.
- Turn starts when right shoulder points in the direction of the throw.
- Turn starts to the left.

### HELP ATHLETES TO:

- Look to ensure the throwing area is clear before commencing the preparation phase.
- Remember for the grip and placement, "Clean palm, dirty neck"
- Develop the focus and balance needed for the phase.



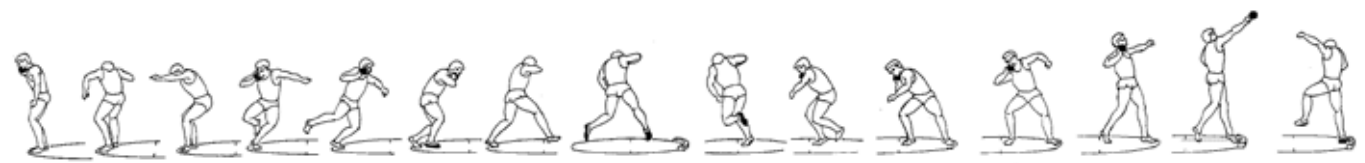

PREPARATION ← → **MOMENTUM BUILDING** ← → DELIVERY ← → RECOVERY

# MOMENTUM BUILDING PHASE

## Part 1

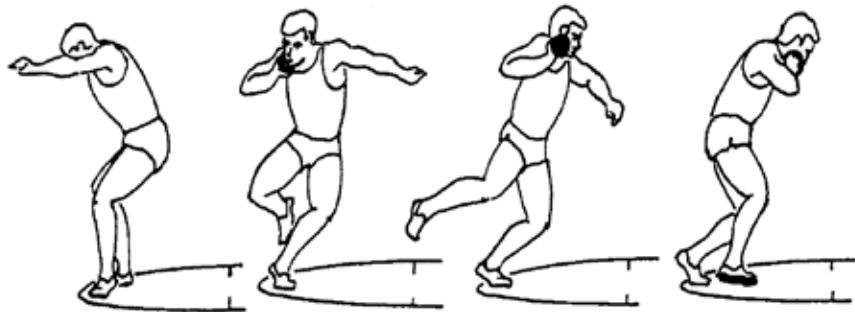

## Objective

To accelerate the thrower and shot.

## Technical characteristics

- Body weight is transferred on to the ball of the left foot, knees are bent.
- Left foot, left knee and straight left arm turn to the left simultaneously.
- Right leg swings wide.
- Shoulders must remain level.
- Initial movement is slow and controlled in the direction of the throw.

### HELP ATHLETES TO:

- Twist and run into the turn rather than jump.
- Develop drills to maintain balance through the turn.
- Keep the shoulders level.

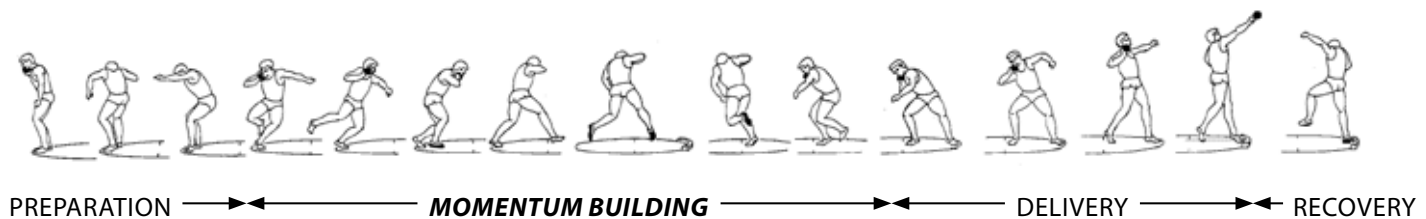

# MOMENTUM BUILDING PHASE

## *Part 2: Non-Support*



SIDE VIEW



REAR VIEW

## Objective

To accelerate the shot and thrower and to prepare for the delivery

## Technical characteristics

- Left knee and toe must have turned completely to the front before drive off of left foot.
- Driving leg is not completely extended.
- Flat jump, lead by a high right knee (leads forwards not upwards).
- Landing is on the ball of the right foot at the centre of the circle.
- Trunk is bent for landing, the left arm folds across the chest.

### COACHES SHOULD:

- Observe the limb positions and the balance in the turn
- Ensure that acceleration is maintained through the phase.
- Ensure a turn, rather than a jump.

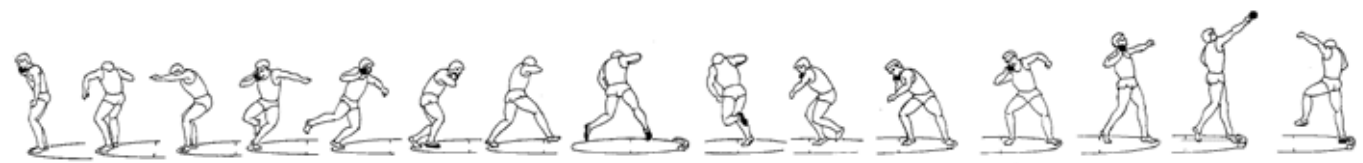

PREPARATION → ← **MOMENTUM BUILDING** → ← DELIVERY → ← RECOVERY

## MOMENTUM BUILDING PHASE

### *Foot Placement*

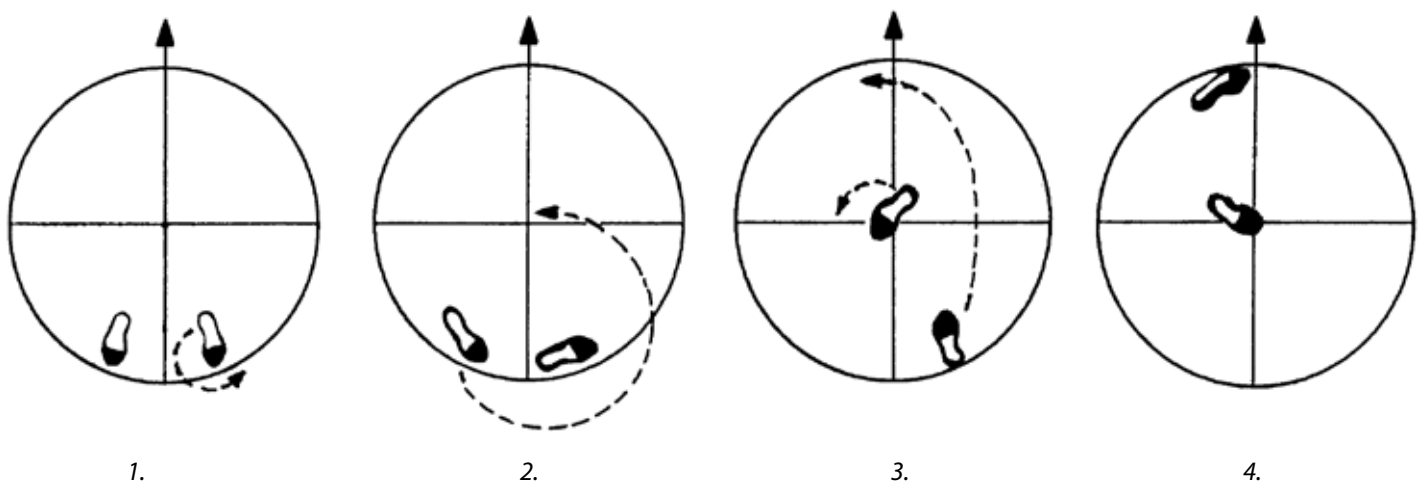

*Power Position*

## Objective

To provide support for the correct body positions.

## Technical characteristics

- Feet are more than shoulder-width apart, turn is to the left on the ball of the left foot. (1)
- Right leg swings over the outside to the centre of the circle. (2)
- Right foot lands on the ball of the foot in the centre of the circle, the left foot lands quickly after the right foot. (3)
- Power position is shorter than in the linear technique ('Heel-Toe' position). (4)

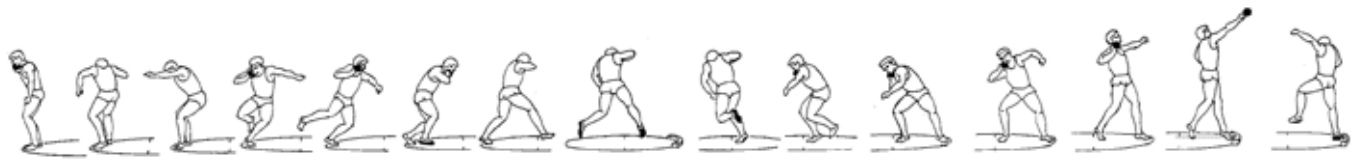

PREPARATION ← → **MOMENTUM BUILDING** ← → DELIVERY ← → RECOVERY

## MOMENTUM BUILDING PHASE

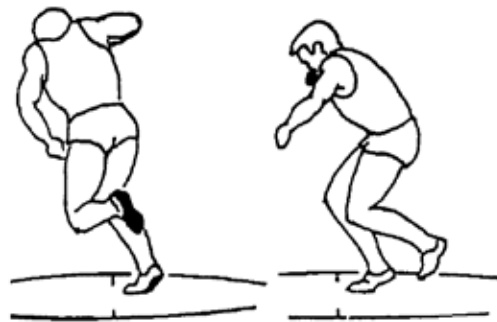

### Objective

To prepare for the Power Position.

### Technical characteristics

- Landing is on the ball of the right foot.
- Body weight is over the right foot.
- Left knee moves close to the right knee and forwards.
- Body is kept closed (left arm is in front of the trunk, head faces the rear of the circle)
- The delivery phase begins when both feet land on the ground.

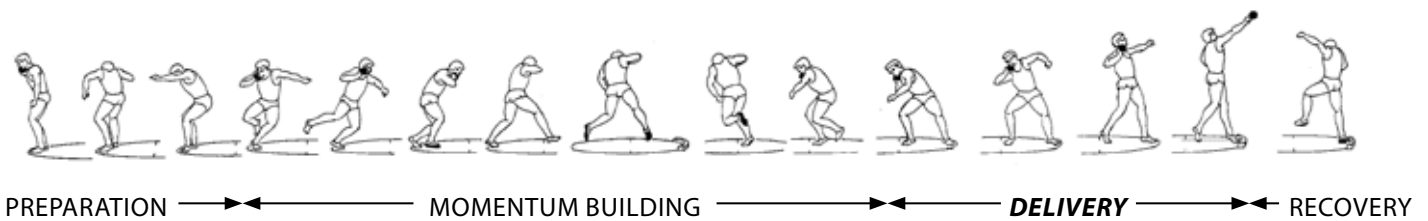

# DELIVERY PHASE

## *Part 1: Power Position*



### HELP ATHLETES TO:

- Gain a balanced alignment in the power position.
- Coordinate the correct timing of, 'big muscles before small'.
- Develop the strength and timing for a braced and 'lifting' left side.



## Objective

To maintain the speed of the shot and begin its main acceleration.

## Technical characteristics

- Body weight is carried mostly on the ball of the right foot, the right knee is bent.
- Ball of the right foot and the heel of left foot are placed on a line: 'Heel-Toe' position.
- Hips and shoulders are twisted.
- Head and shoulders are back.
- Right elbow is at a 90° angle to the trunk.

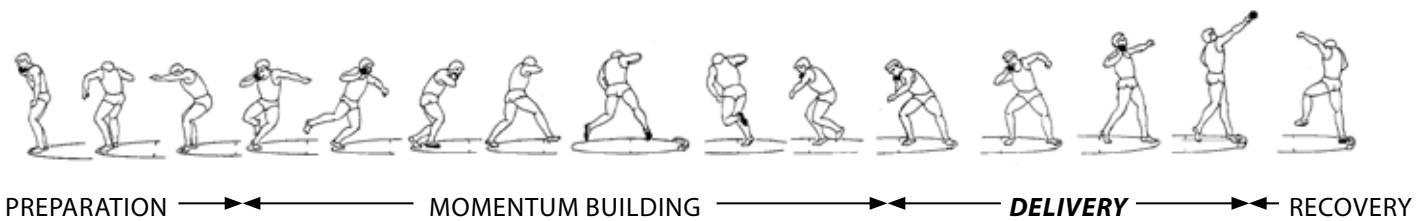

## DELIVERY PHASE

### *Part 2: Main Acceleration*



### Objective

To transfer velocity from the thrower to the shot.

### Technical characteristics

- Right leg is extended and twisted explosively until the right hip faces the front of the circle.
- Left leg is fixed then lifts creating a 'jump' delivery (influencing the angle of release).
- Trunk's twisting movement is blocked by the left arm and shoulder.
- Right elbow is turned and raised in the direction of throw.

#### COACHES SHOULD:

- Observe from the side and rear.
- Ensure the right elbow is kept high.
- Observe the feet, limb and trunk positions through the phase.
- Observe angle of release.

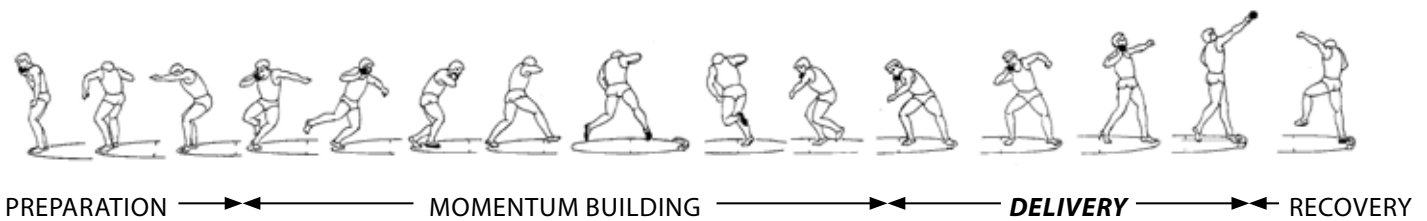

## DELIVERY PHASE

### *Part 3: Final Arm Movement*

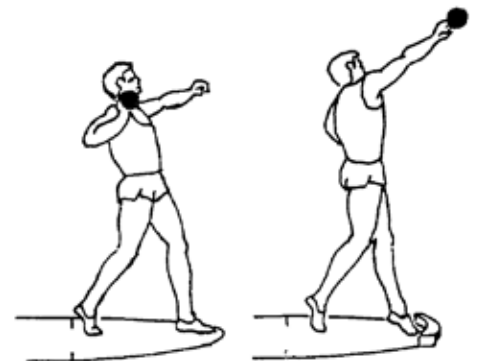

### Objective

To transfer velocity from the thrower to the shot.

### Technical characteristics

- Strike of the putting arm begins after full extension of the legs and trunk.
- Left arm is bent and fixed close to the trunk.
- Acceleration is continued by pre-stretched wrist (fingers turning out after the release).
- Release is made immediately after loss of ground contact.

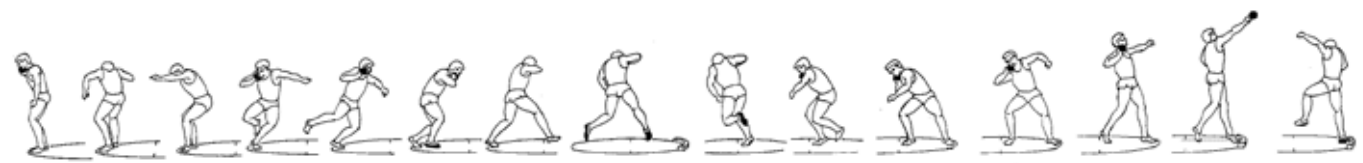

PREPARATION ← → MOMENTUM BUILDING ← → DELIVERY ← → RECOVERY

## RECOVERY PHASE



### COACHES SHOULD:

- Observe from the side and rear.
- Develop practices to time the reverse action.
- Ensure that the athlete has the correct footwear for safety

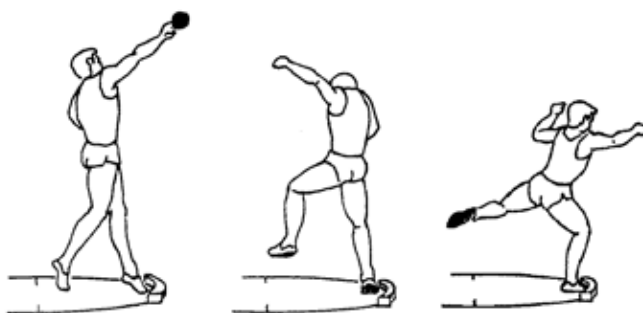

### HELP ATHLETES TO:

- Throw, then recover.
- Recover in an active, relaxed way and stay in the circle.
- Leave the rear of the circle under control.

## Objective

To stabilise the thrower and avoid fouling.

## Technical characteristics

- Legs change quickly after the release.
- Right leg is bent.
- Upper body is lowered.
- Left leg swings backwards.
- Eyes look down.





## STEP 1 INTRODUCTION

### OBJECTIVES:

To get used to the implement and the basic putting movements.

- Introduce the shot, safety measures and grip.
- Slow extension or push upwards,
- Flicking shot with fingers. (1)
- Forward overhead toss. (2)
- Backward overhead toss. (3)



### TIPS:

- 'Clean palm' in the grip.
- Legs before arms.
- Slow to fast.
- Finish 'tall'.

## STEP 2 FRONT PUTS

### OBJECTIVES:

To use legs for acceleration and learn the correct arm strike.

### TIPS:

- Keep the right elbow high.
- Use an appropriate weight shot.

- Stand with feet shoulder-width apart.
- Wind up with bent knees, unwind and throw.
- As for previous drill, but step forwards on to the balls of feet.
- Maintain contact with the ground.

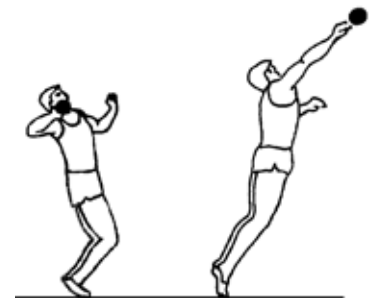

## STEP 3 TURN EXERCISES



### OBJECTIVES:

To develop orientation in the turns.

- Turn continuously along a straight line
- Control the power position after each turn.
- Remain on the balls of the feet.
- With and without shot, no release
- With other implements

### TIPS:

- Use the legs and twisting action to initiate the movement.
- 'Feel' the correct foot placement and balance in the power position.

## STEP 4 ONE-TURN THROW

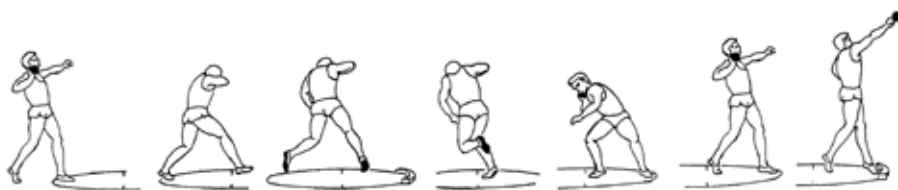

### OBJECTIVES:

To achieve a flat jump and active placement of the right foot.

- Face direction of the throw, step into the circle with the left foot turned inward.
- Drive off from the right leg, turn on the left foot.
- Swing the right leg straight to the centre of the circle, unwind and throw.

### TIPS:

- Adjust starting position in the circle according to the height and experience of the thrower
- In the power position, the alignment should be, 'chin-knee-toe'.
- 'Punch a hole in the sky'.

## STEP 5 ONE-TURN THROW

### OBJECTIVES:

To turn on the ball of the left foot and to couple the turn.

### TIPS:

- Keep shoulders level through the turn.
- Use the swing of the right foot to guide the movement, don't jump.
- Keep hips 'open' with correct right heel, left toe alignment.

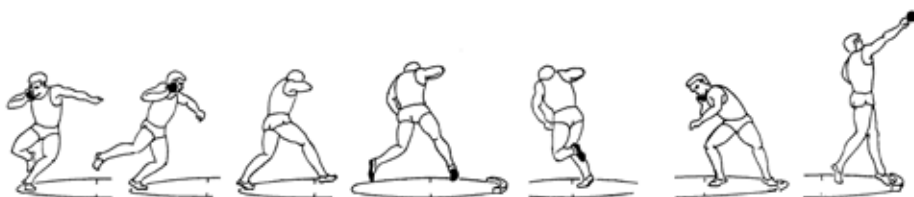

- Start with the left shoulder pointing in the direction of the throw, the left foot inside and right foot outside the circle.
- Turn on ball of the left foot, swing the right leg outside then to the centre of the circle.

## STEP 6 WHOLE SEQUENCE

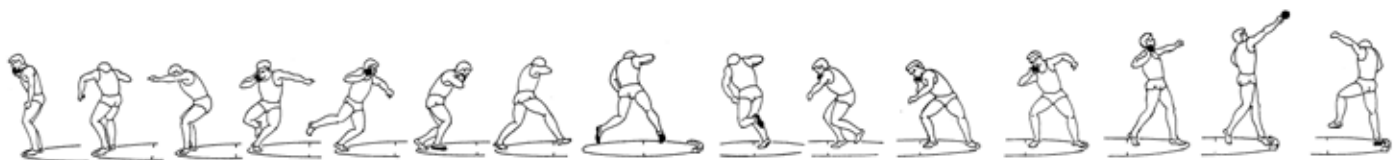

### OBJECTIVES:

To link the phases into a complete movement.

- Perform without and with the shot, controlling and correcting the power position.
- Perform on different surfaces, with eyes closed, different implements (e.g. medicine balls) and different shot weights.

### TIPS:

- Develop the speed and rhythm of the put.
- Be explosive through the delivery and release.
- Think of the whole sequence.



# DISCUS THROW





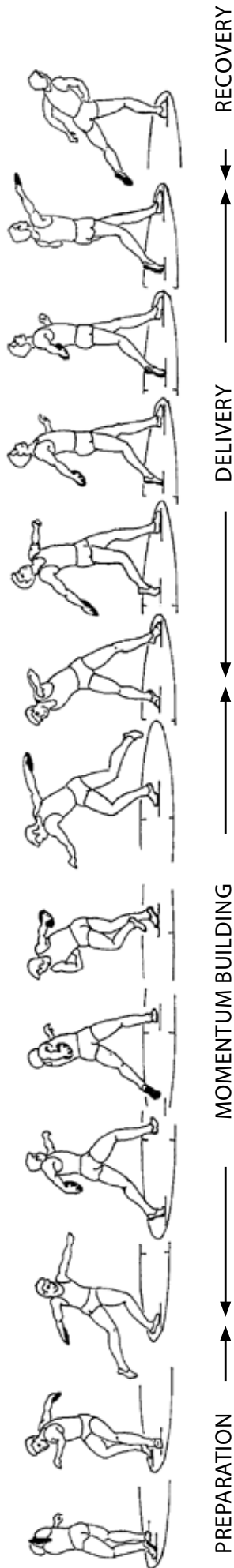

## Discus Throw – Whole Sequence

### Phase Description

The Discus Throw is divided into four phases: PREPARATION, MOMENTUM BUILDING, DELIVERY and RECOVERY.

- In the preparation phase motion is initiated and the thrower moves into position to build momentum.
- In the momentum building phase the discus is accelerated and the lower body rotates ahead of the upper body, producing pre-tension.
- In the delivery phase additional velocity is produced and transferred to the discus before it is released.
- In the recovery phase the thrower braces and avoids fouling.





PREPARATION → ← MOMENTUM BUILDING → ← DELIVERY → ← RECOVERY

## GRIP

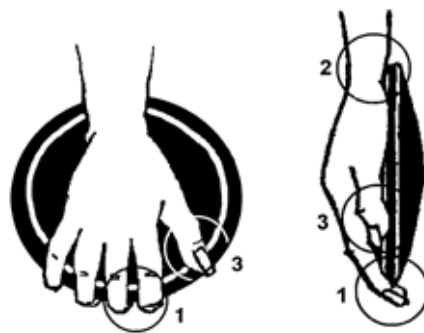

### Objective

To hold the discus firmly for the acceleration and to impart correct rotation on release.

### Technical characteristics

- Discus is held in the last joints of the fingers. (1)
- Fingers are spread on the rim of the discus.
- Wrist is relaxed and straight. (2)
- Discus rests against the base of the hand. (2)
- Thumb rests on the discus. (3)





**PREPARATION** → ← **MOMENTUM BUILDING** → ← **DELIVERY** → ← **RECOVERY**

## PREPARATION PHASE

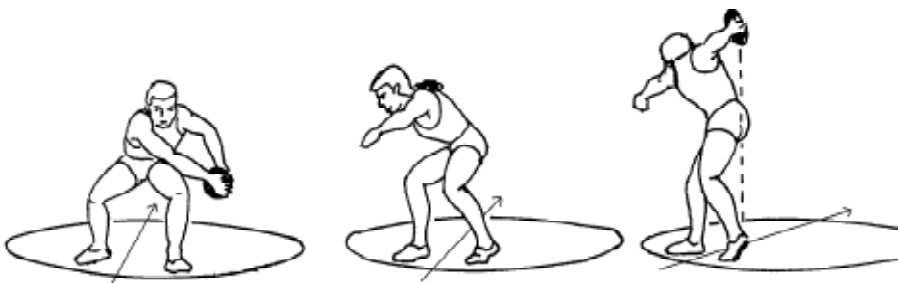

### Objective

To prepare for the turn by winding up and to pre-tense the trunk, shoulders and arm.

### Technical characteristics

- Back faces the direction of the throw.
- Legs are shoulder-width apart, knees bent slightly.
- Weight is on the balls of the feet.
- Discus is swung back and behind up to the vertical projection of the left heel.
- Trunk is rotated at the same time.
- Arms are kept at nearly shoulder height.

#### COACHES SHOULD:

- Create and maintain a SAFE environment.
- Allow enough time for athlete to become familiar with the grip.
- Observe the body and limb positions and stability through the phase.

#### HELP ATHLETES TO:

- Look to ensure the throwing area is clear before commencing the preparation phase.
- Let the discus rest on the hand rather than grasping the implement.
- Develop the balance needed for the phase.



PREPARATION → ← MOMENTUM BUILDING → ← DELIVERY → ← RECOVERY

## MOMENTUM BUILDING PHASE

### Part 1

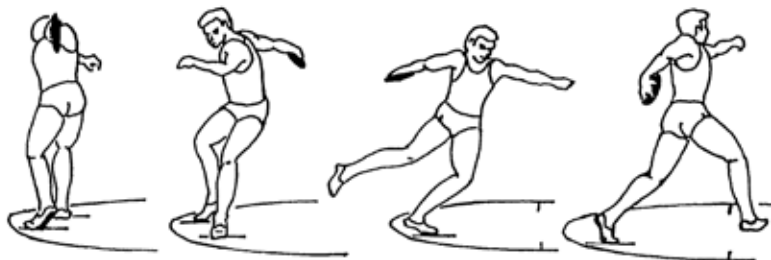

### Objective

To accelerate the thrower and discus and to prepare for the non-support.

### Technical characteristics

- Left knee, left arm and ball of foot are turned actively and simultaneously in the direction of the throw.
- Weight shifts over the bent left leg.
- Throwing shoulder is kept behind the body.
- Right leg is swung low and wide across the circle.

#### COACHES SHOULD:

- Observe the limb positions during the turn.
- Ensure that acceleration is maintained through the phase.
- Ensure a driving action across the circle in the turn rather than a jump.



PREPARATION → ← MOMENTUM BUILDING → ← DELIVERY → ← RECOVERY

## MOMENTUM BUILDING PHASE

### *Part 2: Non-Support*

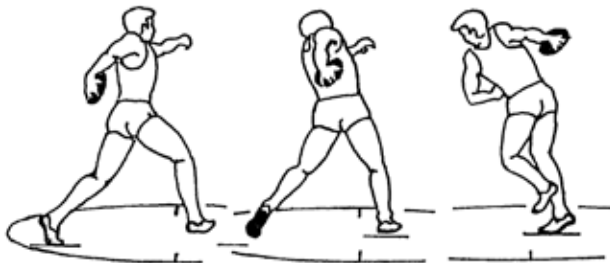

#### HELP ATHLETES TO:

- Execute a 'running turn'.
- Keep the discus at shoulder height.
- Use a stable head to aid balance across the circle.

### Objective

To accelerate the thrower and discus and build up pre-tension in the trunk

### Technical characteristics

- Left foot pushes off forwards when its toes point in the direction of the throw.
- Jump is flat with an incomplete extension of push-off leg.  
Throwing arm is above hip height and behind the body.
- Right foot lands actively on the ball of the foot turning inwards as it does.
- Left arm folds back across chest.
- Left leg brushes past the right knee on its way to the front of the circle.



PREPARATION → ← **MOMENTUM BUILDING** → ← DELIVERY → ← RECOVERY

## MOMENTUM BUILDING PHASE

### *Foot Placement*

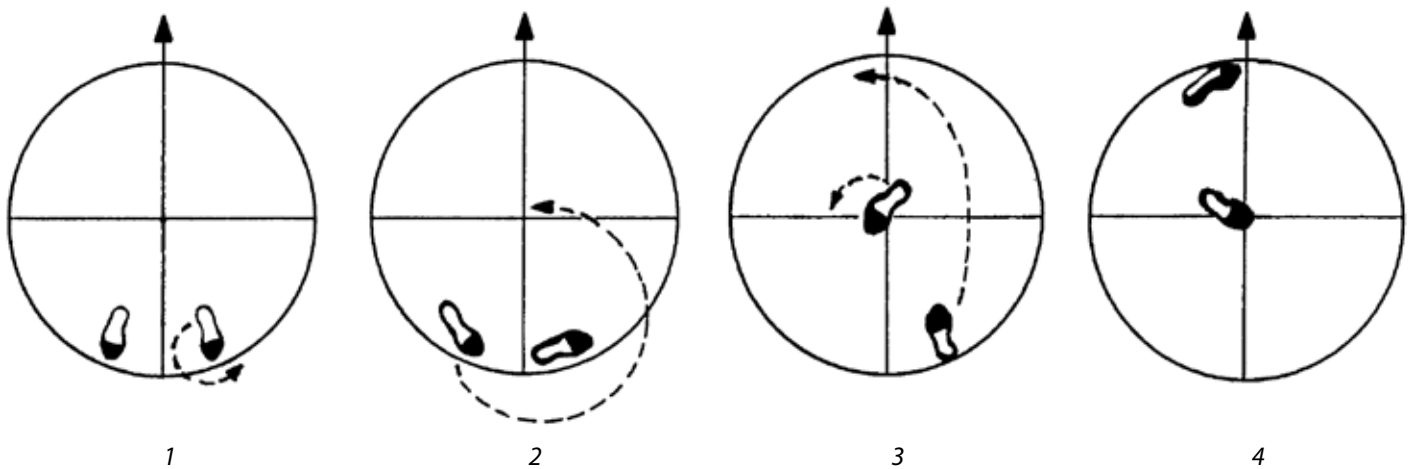

*Power Position*

### Objective

To provide support for the correct body positions.

### Technical characteristics

- Feet are more than shoulder-width apart, turn is to the left on the ball of the left foot. (1)
- Right leg swings over the outside to the centre of the circle. (2)
- Right foot is placed on the ball of the foot in the centre of the circle, the left foot lands quickly after the right foot. (3)
- Power position covers half of the circle (Heel-Toe Position). (4)



PREPARATION → ← MOMENTUM BUILDING → ← DELIVERY → ← RECOVERY

## MOMENTUM BUILDING PHASE

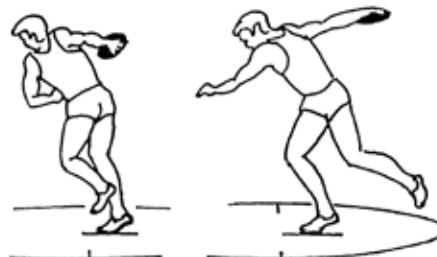

### Objective

To maintain momentum and begin the final acceleration of the discus.

### Technical characteristics

- Right leg is bent.
- Right foot/leg are turned immediately in the direction of the throw.
- Left arm points towards the rear of the circle.
- Discus is at head height.
- Left leg lands quickly after the right leg.
- The delivery phase begins when both feet land on the ground.



PREPARATION → ← MOMENTUM BUILDING → ← **DELIVERY** → ← RECOVERY

## DELIVERY PHASE

### *Part 1: Power Position*

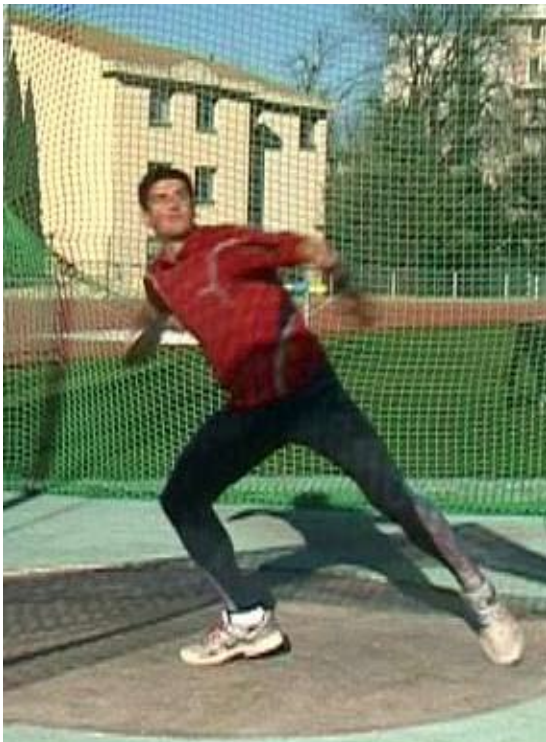

#### HELP ATHLETES TO:

- Gain a 'chin-knee-toe' alignment in the power position.
- Coordinate the correct timing of, 'big muscles before small'.
- Develop the strength for a braced left side.

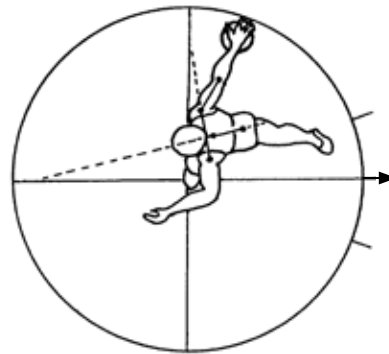

Direction of Throw →



## Objective

To begin the final acceleration.

## Technical characteristics

- Weight is supported on the bent right leg.
- Shoulder axis is over the right foot.
- Feet are in the 'Heel-Toe' position.
- Discus is visible behind the body (from side-view).



PREPARATION → ← MOMENTUM BUILDING → ← DELIVERY → ← RECOVERY

## DELIVERY PHASE

### *Part 2: Main Acceleration*

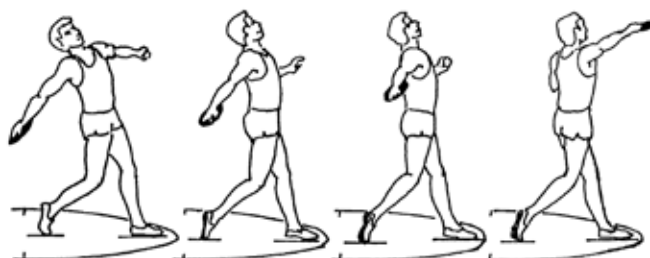
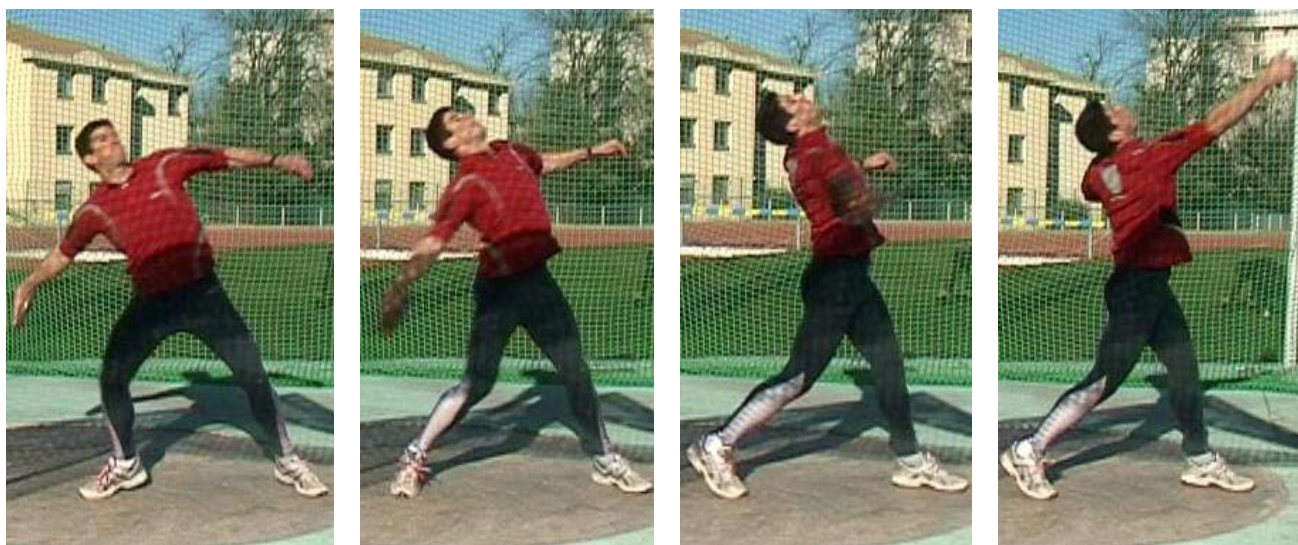

### Objective

To transfer velocity from the thrower to the discus.

### Technical characteristics

- Right leg is twisted and extended explosively.
- Right hip turns towards the front of circle.
- Left side of the body is blocked by the extension of the left leg and the fixing of the bent left elbow held close to trunk.
- Body weight is shifted from the right leg to left.
- Throwing arm is drawn through after both feet have made ground contact and the hip has turned.
- Discus leaves the hand at or slightly below shoulder height (shoulders are parallel!).

#### COACHES SHOULD:

- Observe from the side and rear.
- Ensure that the throwing arm is kept high and behind the body.
- Observe the feet, limb and trunk positions through the phase.
- Observe angle of release.



PREPARATION → ← MOMENTUM BUILDING → ← DELIVERY → ← RECOVERY

## RECOVERY PHASE



### COACHES SHOULD:

- Observe from the side and rear.
- Develop practices to time the reverse action.
- Ensure that the athlete has the correct footwear for safety

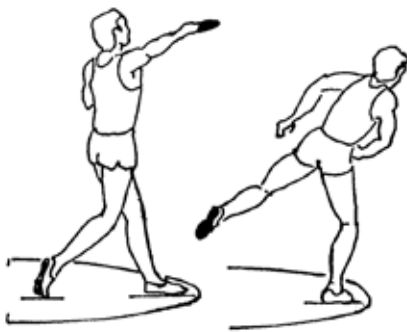

### HELP ATHLETES TO:

- Throw, then recover.
- Recover in an active, relaxed way and stay in the circle.
- Leave the rear of the circle under control.

## Objective

To stabilise the thrower and avoid fouling.

## Technical characteristics

- Legs change quickly after release.
- Right leg is bent.
- Upper body is lowered.
- Left leg swings backwards.





## STEP 1 INTRODUCTION

### OBJECTIVES:

To get used to the discus and learn to rotate it correctly.

- Introduce the discus, safety measures and grip.
- Bowl the discus on the ground to a partner, releasing off the index finger.
- Modify the bowl to flip/toss the discus in the air.

### TIPS:

- Don't grab the discus.
- Bend the legs to release the discus when bowling on the ground.
- Feel the rotation off the index finger.

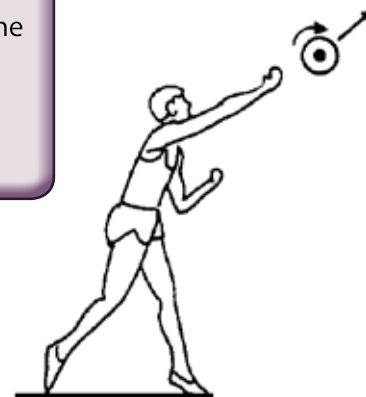

## STEP 2 STANDING FRONT THROW

### OBJECTIVES:

To learn to throw straight from a rotational acceleration.

### TIPS:

- Relax into the backward swing and move actively to unwind.
- Keep the discus moving to prevent the discus from falling out of the hand.

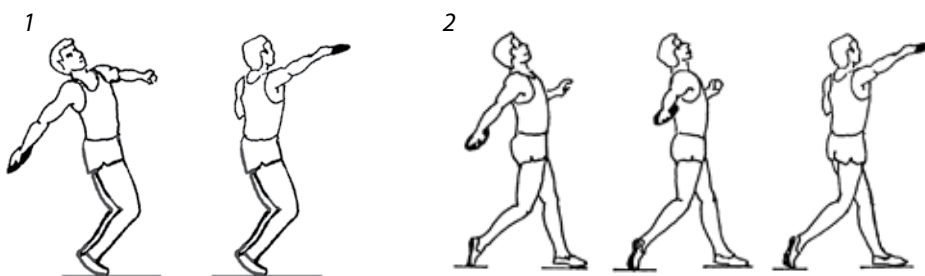

- Start with feet parallel (1) or from split-leg position (2).
- Wind up backwards, use legs for acceleration, unwind and throw.
- Use other implements (e.g. rings, light medicine balls); throw at target.

## STEP 3 STANDING SIDE THROW

### OBJECTIVES:

To learn use of right leg, the hip activity and the blocking action.

### TIPS:

- Keep the discus about head height.
- Feel the release of the index finger.
- Recover naturally if needed.

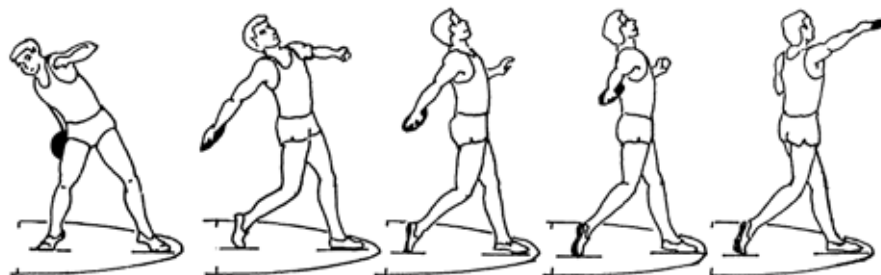

- Start with left shoulder in direction of the throw, feet 1 1/2 shoulder-widths apart.
- Swing discus backwards, pivoting on the right foot.
- Turn right heel out while pushing the right hip forwards, block with left leg.

## STEP 4 STANDING THROW FROM POWER POSITION

### OBJECTIVES:

To learn the activity of the right leg, the turn of legs, hips and shoulders.

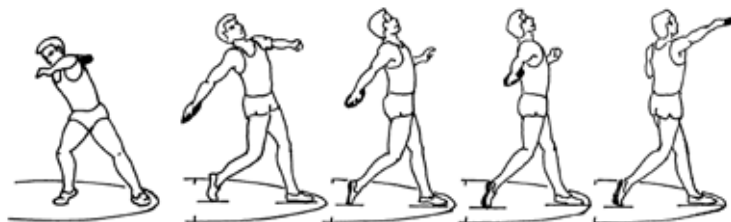

### TIPS:

- In the power position, the alignment should be, 'chin-knee-toe'.
- Feel the index finger releasing the discus.
- The more spin on the discus the more stability in the air.

- Start with back facing the direction of the throw.
- Initiate the throw with a vigorous action of the right hip turning to the front.
- Swing the discus backwards-upwards with palm down (do not break the movement).

## STEP 5 ONE-TURN THROW

### OBJECTIVES:

To introduce one complete turn.



### TIPS:

- Keep throwing arm up.
- Run across the circle while turning. Don't jump.
- Keep hips 'open' with correct right heel, left toe alignment.

- Start outside the circle facing the direction of throw with discus behind the body.
- Step into circle with inward turned left foot (pointed to the left).
- Turn forwards on the left foot, continue with active right foot into power position, throw.

## STEP 6 WHOLE SEQUENCE



### OBJECTIVES:

To link the phases into a complete movement.

- Perform the complete sequence controlling and correcting the power position.
- Perform with lighter discs.
- Perform with different implements (e.g. rings, light medicine balls).

### TIPS:

- Develop the speed and rhythm of the throw.
- Be explosive through the delivery and release.
- Think of the whole sequence.



# HAMMER THROW



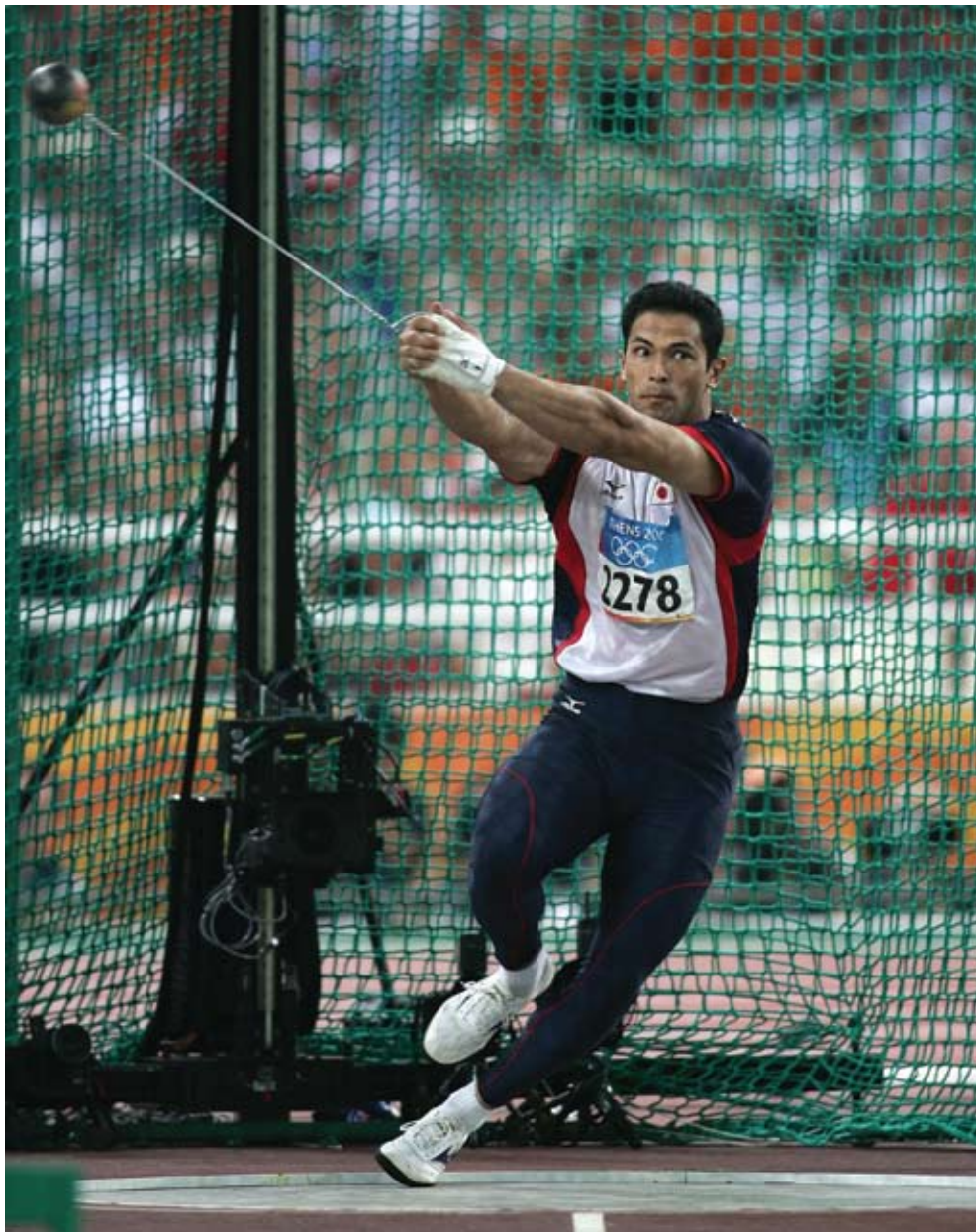

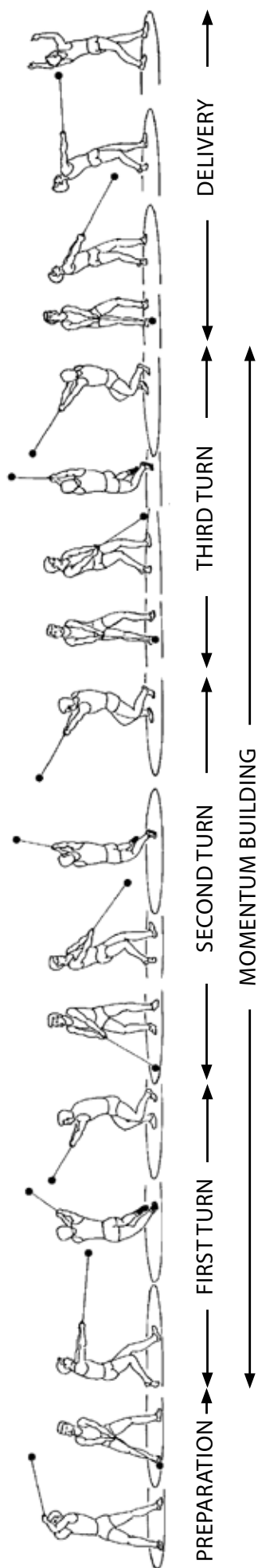

# Hammer Throw – Whole Sequence

## Phase Description

The Hammer throw technique is divided into the following phases: PREPARATION, MOMENTUM BUILDING and DELIVERY.

- In the preparation or swings phase the motion of the hammer is initiated and the thrower moves into position for the momentum building phase, the turns.
- In the momentum building phase the thrower and hammer are accelerated through 3 or 4 turns.
- In the delivery phase additional velocity is produced and transferred to the hammer before it is released.
- There is no specific recovery phase in the hammer throw, the thrower remains in the delivery position.



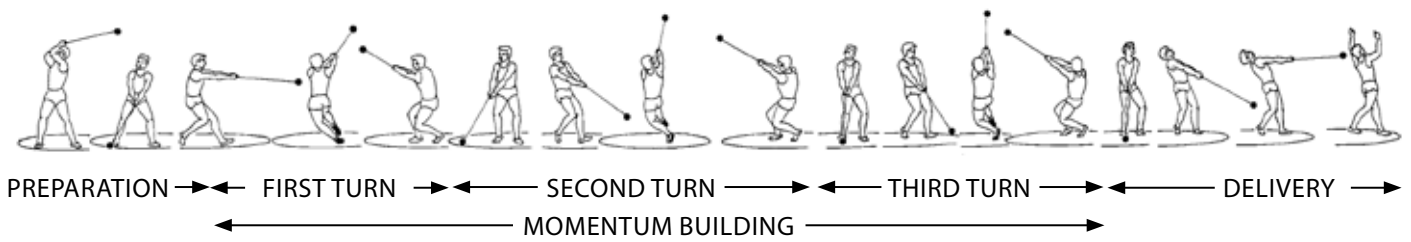

## GRIP

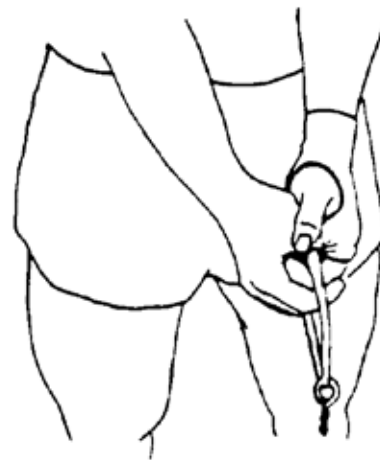

### Objective

To resist the pull and ensure the correct direction of throw.

### Technical characteristics

- Right handed throwers hold the handle with left hand.
- Handle is placed on the middle section of the fingers.
- Right hand covers the left hand.
- Grip is closed by crossing the thumbs or holding them parallel.
- Grip is strong but relaxed.



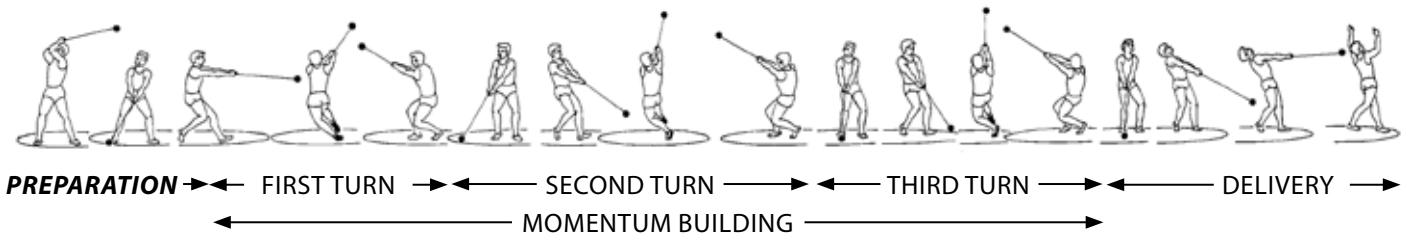

# PREPARATION PHASE

## *Starting Position*

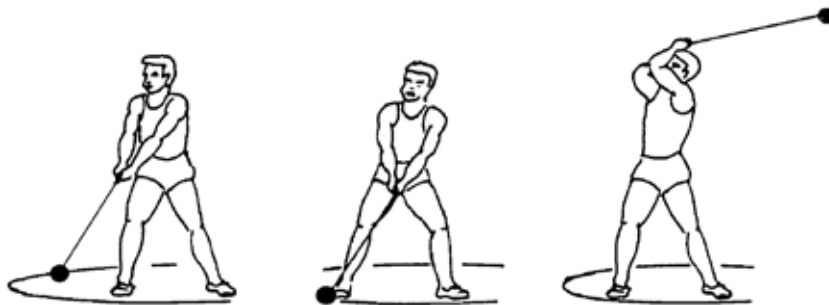

## Objective

To initiate the acceleration of the hammer.

## Technical characteristics

Alternatives to start the swings:

- Hammer lays on the ground to the back of the thrower's right side and is pulled to the left and upwards.
- Swings are started with a pendulum movement of the hammer between and beside the thrower's legs.

### COACHES SHOULD:

- Create and maintain a SAFE environment.
- Ensure that the athlete has the correct footwear for safety.
- Ensure that athlete holds hammer correctly.
- Observe the movement and relaxation in the preliminary swings.

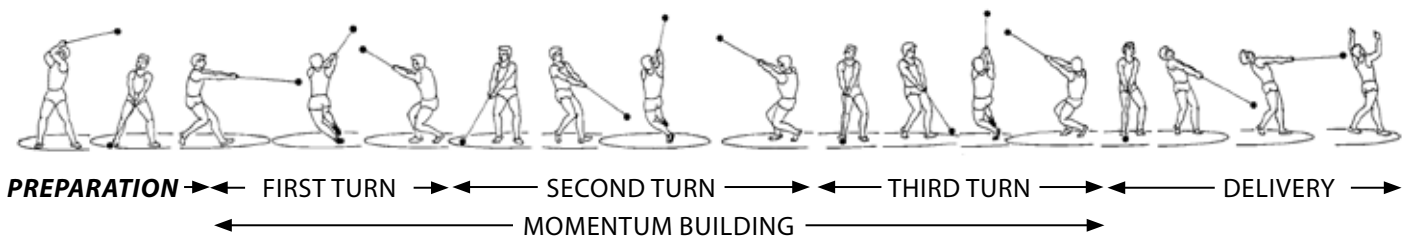

## PREPARATION PHASE

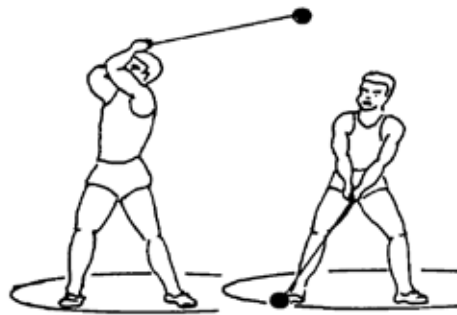

### Objective

To accelerate the hammer and prepare for the first turn.

### Technical characteristics

- Feet are slightly more than shoulder-width apart, torso is vertical.
- Body weight shifted visibly, corresponding to the hammer's orbit.
- Trunk is twisted to the right side when the hammer reaches the high point of its orbit ("look through window formed by arms").
- Low point of the hammer's orbit is in front of the right foot.
- 2-3 wide and flat preliminary swings.
- Speed is increased gradually from swing to swing.

#### HELP ATHLETES TO:

- "Look through the window formed by the arms" at the hammer's high point.
- Rehearse preliminary swings preparatory to entry.
- Let the hammer flow with straight arms all the time
- Feel the rhythm and the gradual acceleration.

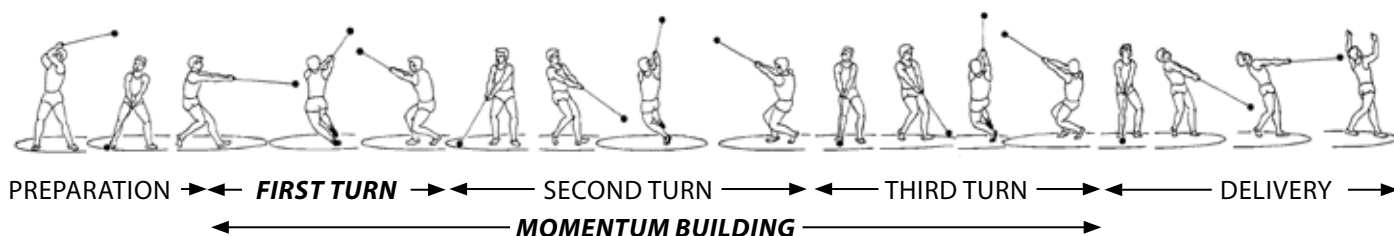

## MOMENTUM BUILDING PHASE

### *First Turn - Transition*

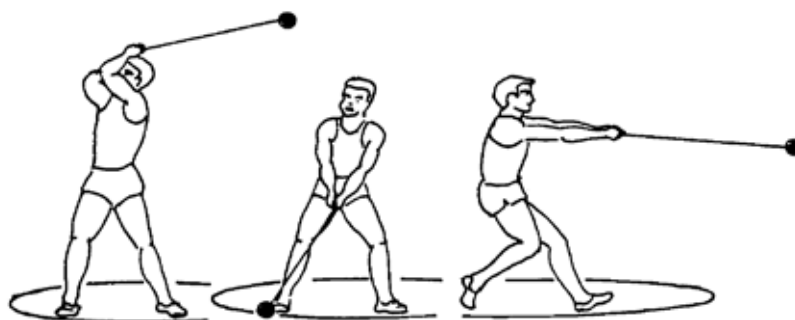

### Objective

To link the swings with the first turn and accelerate the thrower and hammer.

### Technical characteristics

- Knees are bent, the trunk is upright, and arms are extended.
- Foot movement commences when the hammer reaches the low point of its orbit.
- Pivot is on the heel of the left foot, push off is from the right foot, eyes should focus on hammer.
- Right side of the body is turned actively around the fixed left side.

#### COACHES SHOULD:

- Ensure a smooth transition from the swings to the turns.
- Observe the athlete's movement over the left foot.
- Observe the extension and relaxation of the arms from various positions.

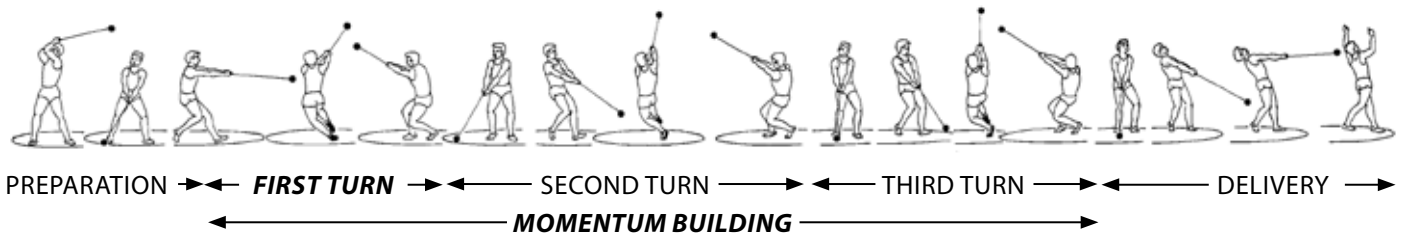

## MOMENTUM BUILDING PHASE

### *First Turn*



## Objective

To develop pre-tension (in the single support) and accelerate the hammer (in the double support).

## Technical characteristics

- Heel-Ball Turn:
- Pivot on the heel of the left foot, push off from the right foot;
- Change from the heel to the ball of the left foot (over edge of the shoe);
- Continue with quick pivot on ball of the left foot;
- Close, low turning movement of the right foot/leg around the left leg;
- Place the right foot on the ground quickly and smoothly.

### HELP ATHLETES TO:

- Turn round rather than trying to move ahead of the hammer.
- Keep hands below shoulder level, with active bent legs.
- Keep arms passive, elbows close together and feel 'pull' in the shoulders.
- Improve strength / conditioning - torso core stability exercises.

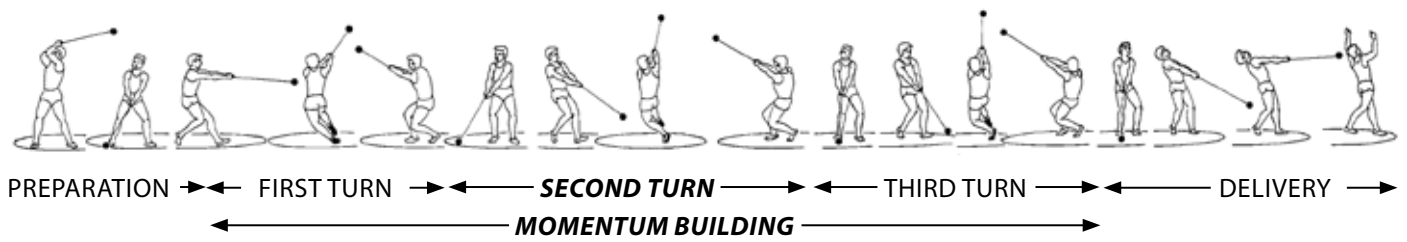

# MOMENTUM BUILDING PHASE

## *Second Turn*

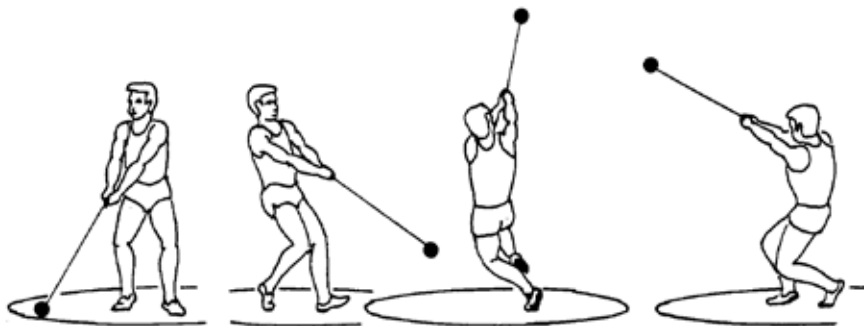

## Objective

To develop pre-tension (in the single support) and accelerate the hammer (in the double support).

## Technical characteristics

- Heel-Ball Turn ( $\frac{1}{3}$  of turn on heel,  $\frac{2}{3}$  of turn on ball).
- Body weight is on the left leg, which remains bent.
- Body sits visibly against the hammer.
- Shoulder-axis and the arms form a triangle.
- Hips move ahead of shoulder during right foot touchdown causing pre-tension.

### COACHES SHOULD:

- Ensure that thrower and hammer are moving together and in rhythm.
- Observe the position of the body and limbs from the front and side.
- Observe the single support and double support phases. various positions.

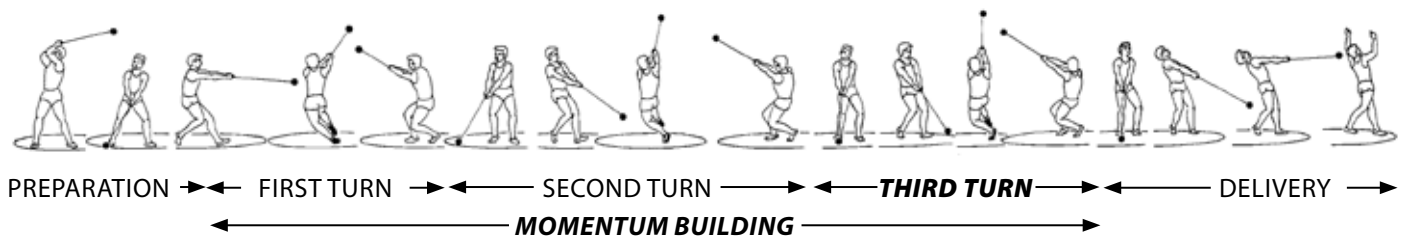

## MOMENTUM BUILDING PHASE

### *Third Turn*

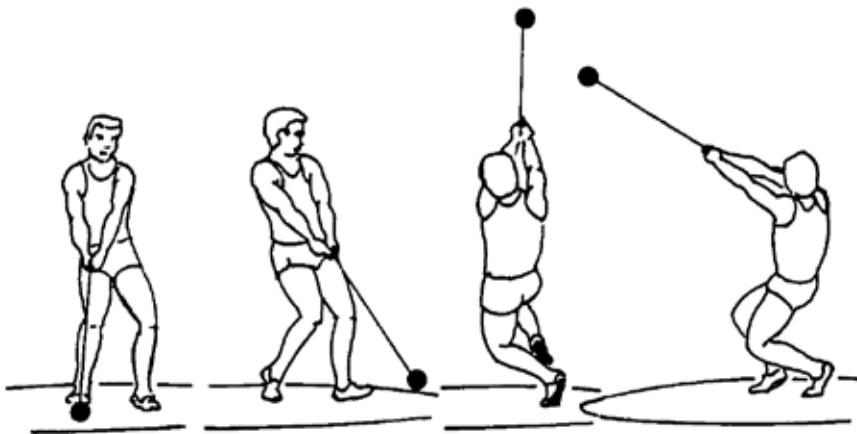

#### HELP ATHLETES TO:

- 'Dance with the hammer'.
- Keep hands below shoulder level, with active bent legs.
- Use heel-toe turn drills to enhance the skill of the movement.
- Accelerate the hammer during its downward travel from high point toward low point.
- Maintain balance and increasing velocity through the turns.

### Objective

To develop pre-tension (in the single support) and accelerate the hammer (in the double support).

### Technical characteristics

- Heel-Ball Turn.
- Height of the low point of the orbit is reduced from turn to turn.
- Foot separation is reduced from turn to turn.
- Rotational velocity is increased from turn to turn.

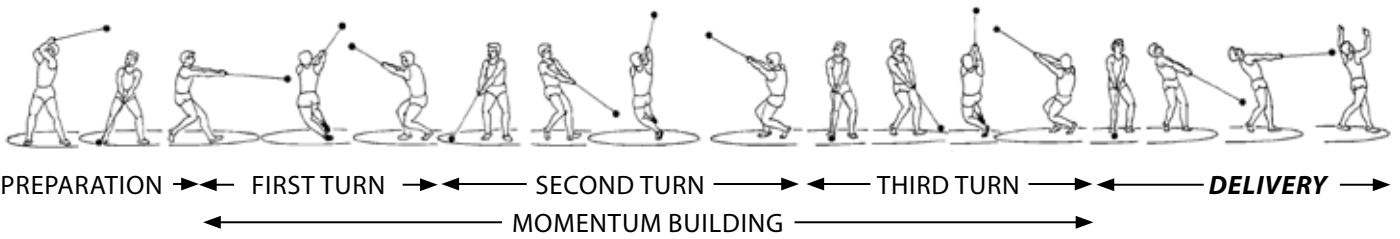

## DELIVERY PHASE

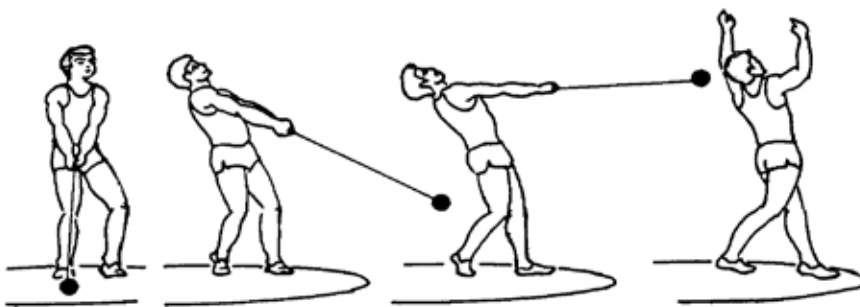

### COACHES SHOULD:

- Observe the delivery from the side and rear.
- Ensure the arms move upwards and to the left in a whiplash action.
- Develop practices to time the release.

## Objective

To transfer velocity from the thrower to the hammer.

## Technical characteristics

- Legs are extended rapidly when the hammer reaches the low point of its orbit.
- Pushoff of the right foot/leg is active, turning the right hip to the front.
- Left side is blocked when the hip axis points in the direction of the throw.
- Arms move upwards and to the left, in a whiplash movement.
- Hammer is released when the shoulder axis points in the direction of the throw.

### HELP ATHLETES TO:

- Use delivery drills to stabilise this aspect of the throw.
- Have a very fast right foot placement so that maximum torque can be felt in the trunk.
- Extend both legs to as straight as possible during delivery.
- Use the legs explosively to pull upwards before release of the hammer.

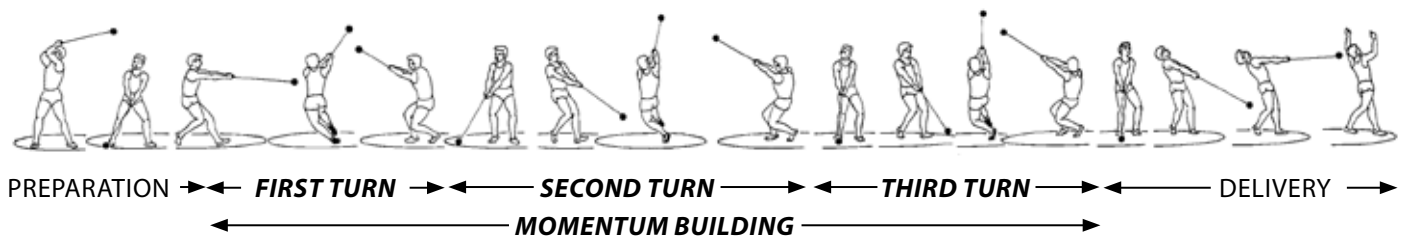

## FOOT PLACEMENT

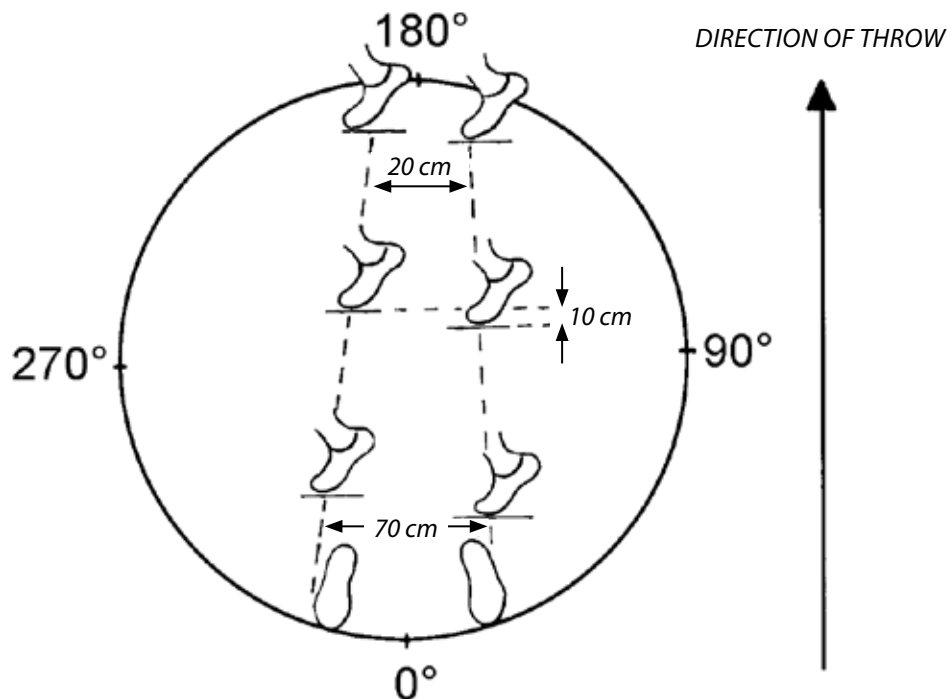

### Objective

To achieve correct body positions for acceleration.

### Technical characteristics

- Preliminary swings are with the feet more than shoulder-width apart (approximately 70 cm).
- Foot separation is reduced from turn to turn.
- Feet are staggered by about 10 cm.
- Feet point to the right after one turn (between 220-280°).



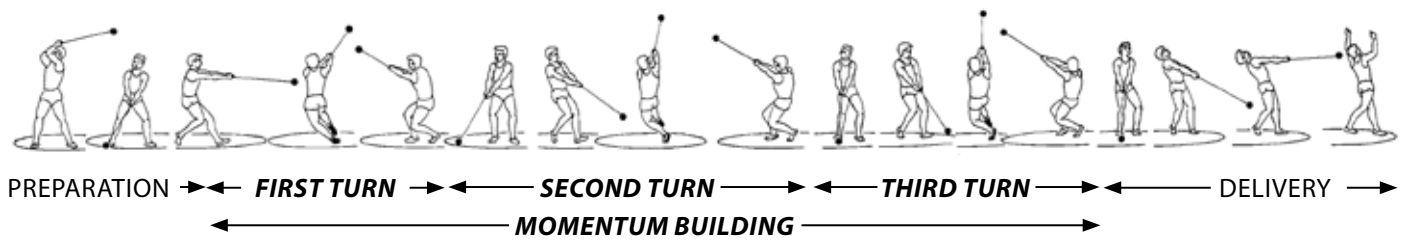

## FOOT PLACEMENT

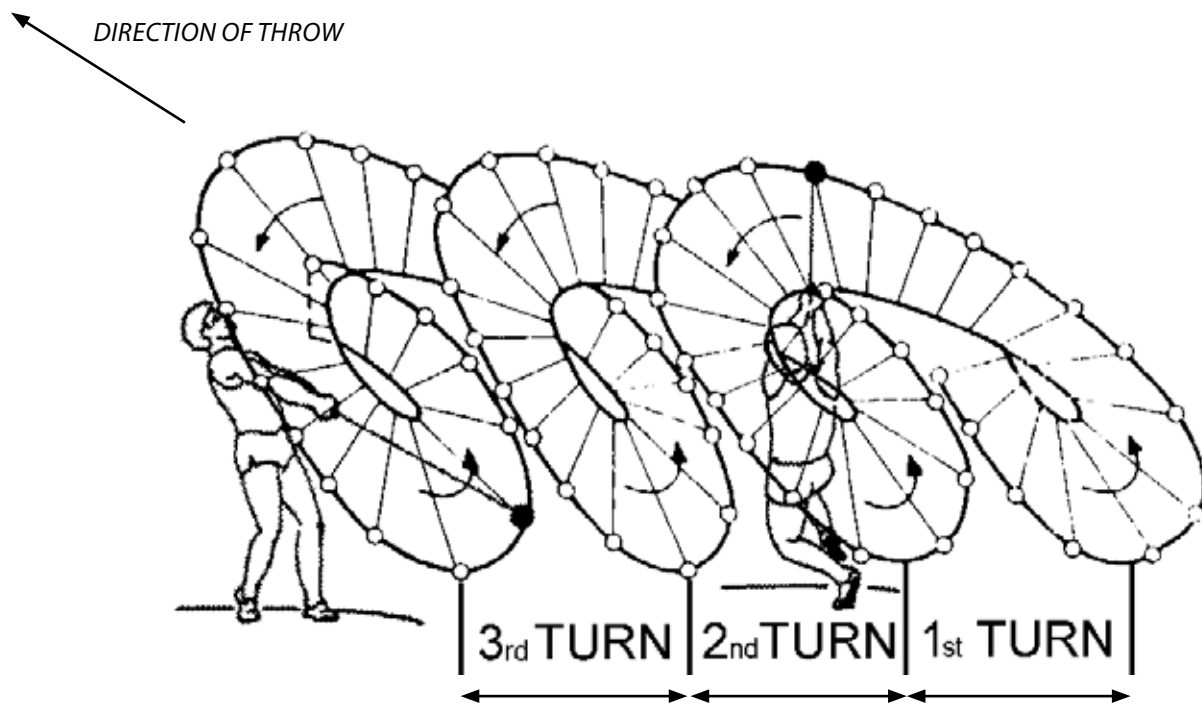

### Objective

To achieve correct placement of high and low points of the orbit.

### Technical characteristics

From turn to turn:

- Orbit becomes steeper;
- Low point moves left towards the centre at the rear of the circle;
- High point moves to the centre at the front of the circle.

## STEP 1 INTRODUCTION

### OBJECTIVES:

To learn use of the whole body for acceleration in a backward throw.

- Introduce safety measures.
- Use legs for acceleration.
- Keep back straight, arms extended.
- Sling over the left shoulder.
- Variations: use improvised implements.

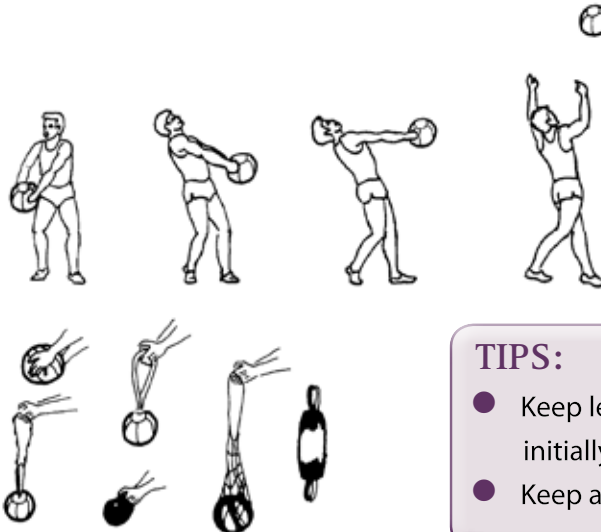

### TIPS:

- Keep legs slightly bent initially, then extend.
- Keep arms extended.

## STEP 2 STANDING SWINGS

### OBJECTIVES:

To introduce swinging and find a balanced position.

- Introduce implement and grip. Stand with feet slightly more than shoulder-width apart.
- Swing hammer between the legs, to the right side then left.
- Swing several times without releasing.

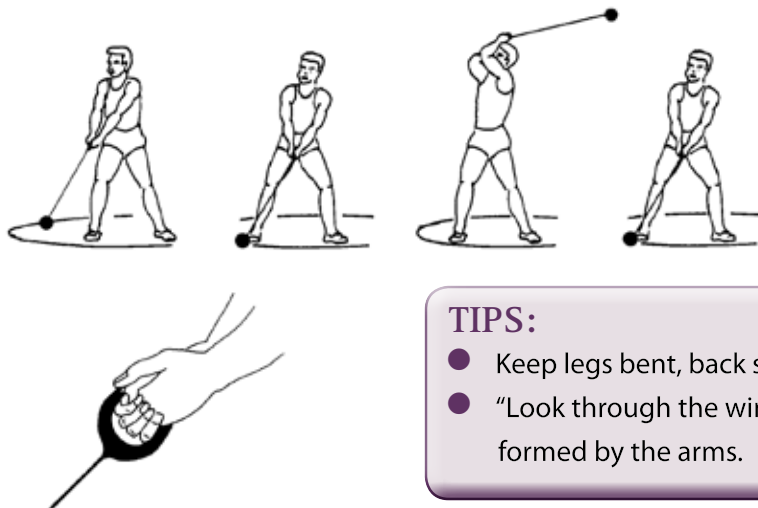

### TIPS:

- Keep legs bent, back straight.
- “Look through the window” formed by the arms.

## STEP 3 STANDING THROW

### OBJECTIVES:

To introduce the delivery and link it with swings.

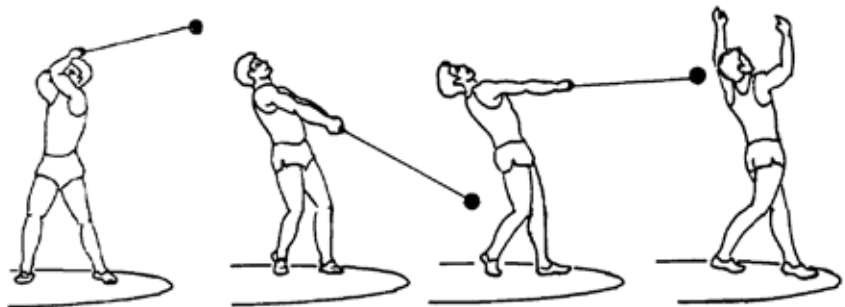

### TIPS:

- ‘Sit down and stay seated’ during the swings.
- Accelerate into the release.
- Time the leg extension.

- Use same starting position as for Step 2.
- After 2 swings throw the hammer over the left shoulder.
- Remain in fixed position after release, follow hammer flight with eyes.

## STEP 4 INTRODUCTION TO TURNING

### OBJECTIVES:

To introduce the turn and develop orientation during rotations.

#### TIPS:

- Focus on the end of the stick.
- Try and do this slowly, controlled and with balance.
- Let the hammer take you round – don't turn ahead of the hammer.

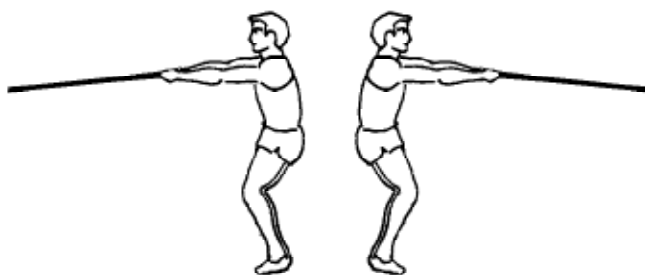

- Hold a stick with extended arms, feet shoulder-width apart, knees slightly bent.
- Turn on the spot by moving the feet anti-clockwise.
- Keep eyes on the end of the stick, repeat, replacing the stick with hammer.

## STEP 5 HEEL-TOE TURNS

### OBJECTIVES:

To introduce the Heel-Toe turn.

#### TIPS:

- Wear suitable footwear.
- Hold a stick in the hands to aid balance.
- Try and do this slowly, controlled and with balance.
- Complete several turns as skill develops.

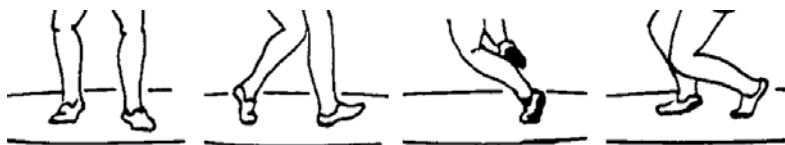

- Turn through 180° balanced on the heel of left foot, pivoting on to the ball of right foot.
- Continue turn another 180° balanced on the ball of the left foot while lifting the right foot.
- Place the right foot down to complete a 360° turn.

## STEP 6 COMPLETE SEQUENCE (2 SWINGS AND 1 TURN)

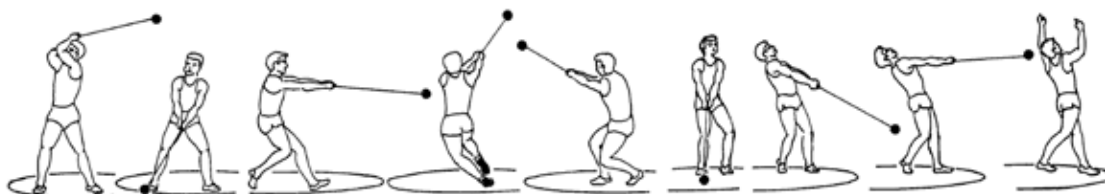

### OBJECTIVES:

To link the phases into a whole, but shortened, competition movement.

- Take two preliminary swings and commence the turn.
- Use one heel-toe turn and delivery.
- Use alternative implements.

#### TIPS:

- Swings must be fast enough for the hammer to take the thrower round
- Keep the plane of the hammer path shallow.
- Gradually increase the pace of the rhythm as confidence develops.





# RUN JUMP & THROW!

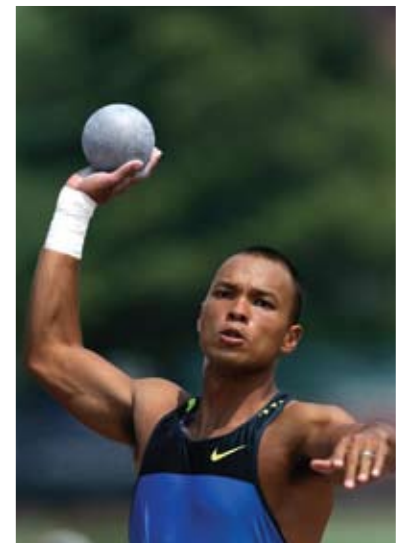

# COMBINED EVENTS



# THE COMBINED EVENTS

The Combined Events are competitions where athletes have to do a number of running, jumping and throwing events, all combined together. The performance of the athlete in each event is converted to a 'point value', using special scoring tables, and the points are totalled or 'combined' during the competition to give the result. The athlete with the most points wins.

In athletics, you will also come across the term 'Multi-Events'. 'Multi-Events' now means that athletes are performing a mixture of running, jumping and throwing events but the performances are separate events, the performances are not converted to a point value. We have seen that the 'Multi-Events' stage is an early stage of the IAAF Athlete Development pathway when young and novice athletes should try all events, aiming for variety. This experimenting and experiencing of all events should take place in training and also in the selection of competitions. In this way young and novice athletes are exposed to all events, developing the various running, jumping and throwing techniques. Along with this technical development is a parallel development of the capacities of speed, strength, endurance, as well as flexibility and coordination.

As athletes progress, through training and competitive experiences, along the IAAF Athlete Development pathway they enter the 'Event Group Development' stage. In athletics there are six event groups: Sprints & Hurdles, Middle & Long Distance Running, Race Walks, Jumps, Throws and the Combined Events.

The Combined Events include the Decathlon, comprised of 10 events, for senior men and Heptathlon, comprised of 7 events, for senior women. Junior athletes do the same events as senior athletes but with the age-group appropriate height of hurdles and weights of throwing implements. The standard Combined Events competition for senior and junior athletes takes place over two days. Youth athletes may compete in the Octathlon (8 events) for boys and Heptathlon (7 events) for girls. Younger athletes may compete in the Pentathlon (5 events), or in other combinations of events such as the Triathlon (3 events) with a choice of one run, one jump and one throw. In 2001, the Decathlon was formally recognised by the IAAF for senior women but at the time of the publication of this book in 2009, the women's Decathlon has not been contested in a major Championship.

## Senior Men's Decathlon

First Day: 100m, Long Jump, Shot Put, High Jump, 400m

Second Day: 110m Hurdles, Discus, Pole Vault, Javelin, 1500m

## Senior Women's Heptathlon

First Day: 100m Hurdles, High Jump, Shot Put, 200m

Second Day: Long Jump, Javelin, 800m

The good performer in the Combined Events will have a balanced development and all-round abilities and may not be the athlete who 'wins' most events. This is reflected in the following scoring tables of the Decathlon and Heptathlon competitions from the 2007 World Championships, Osaka, Japan.



**The Scoring Tables**

Example: Men's Decathlon – 2007 World Championship, Osaka Japan

	Athlete	MF	100m	LJ	SP	HJ	400m	110mH	Discus	PV	Javelin	1500m	Points
1	Roman Šebrle	CZE	11.04	7.56	15.92	2.12	48.80	14.33	48.75	4.80	71.18	4:35.32	8676
			852	950	846	915	871	932	844	849	907	710	
2	Maurice Smith	JAM	10.62	7.50	17.32	1.97	47.48	13.91	52.36	4.80	53.61	4:33.52	8644
			947	935	933	776	934	986	920	849	642	722	
3	Dmitriy Karpov	KAZ	10.70	7.19	16.08	2.06	47.44	14.03	48.95	5.00	59.84	4:39.68	8586
			929	859	856	859	936	971	849	910	735	682	
4	Aleksey Drozdov	RUS	10.97	7.25	16.49	2.12	50.00	14.76	48.62	5.00	63.51	4:36.93	8475
			867	874	882	915	815	879	842	910	791	700	
5	André Niklaus	GER	11.12	7.42	14.12	2.06	49.40	14.51	44.48	5.30	63.28	4:32.50	8371
			834	915	736	859	842	910	756	1004	787	728	
6	Aleksey Sysoyev	RUS	10.80	7.01	16.16	2.03	48.42	14.59	49.76	4.90	57.75	4:36.16	8357
			906	816	861	831	889	900	865	880	704	705	

 Leading performance for this event out of all decathletes

Example: Women's Heptathlon – 2007 World Championship, Osaka Japan

	Athlete	MF	100mH	HJ	SP	200m	LJ	Javelin	800m	Points
1	Carolina Klüft	SWE	13.15	1.95	14.81	23.38	6.85	47.98	2:12.56	7032
			1102	1171	848	1041	1122	821	927	
2	Lyudmila Blonska	UKR	13.25	1.92	14.44	24.09	6.88	47.77	2:16.68	6832
			1087	1132	823	972	1132	817	869	
3	Kelly Sotherton	GBR	13.21	1.86	14.14	23.40	6.68	31.90	2:11.58	6510
			1093	1054	803	1039	1066	513	942	
4	Jessica Ennis	GBR	12.97	1.89	11.93	23.15	6.33	38.07	2:11.39	6469
			1129	1093	656	1064	953	630	944	
5	Lilli Schwarzkopf	GER	13.54	1.83	13.00	25.08	6.17	54.44	2:12.76	6439
			1044	1016	727	879	902	946	925	
6	Austra Skujyte	LTU	14.34	1.80	17.03	25.39	6.28	52.63	2:23.64	6380
			931	978	997	851	937	911	775	

 Leading performance for this event out of all heptathletes

**Combined Events and Athlete Development**

In the 'Kids' Athletics' and 'Multi-Events' stages of the IAAF Athlete Development pathway, all athletes should do all events and all event groups. As they enter the 'Event Group Development' stage some athletes enjoy doing all events equally and may continue this by choosing the Combined Events event group.

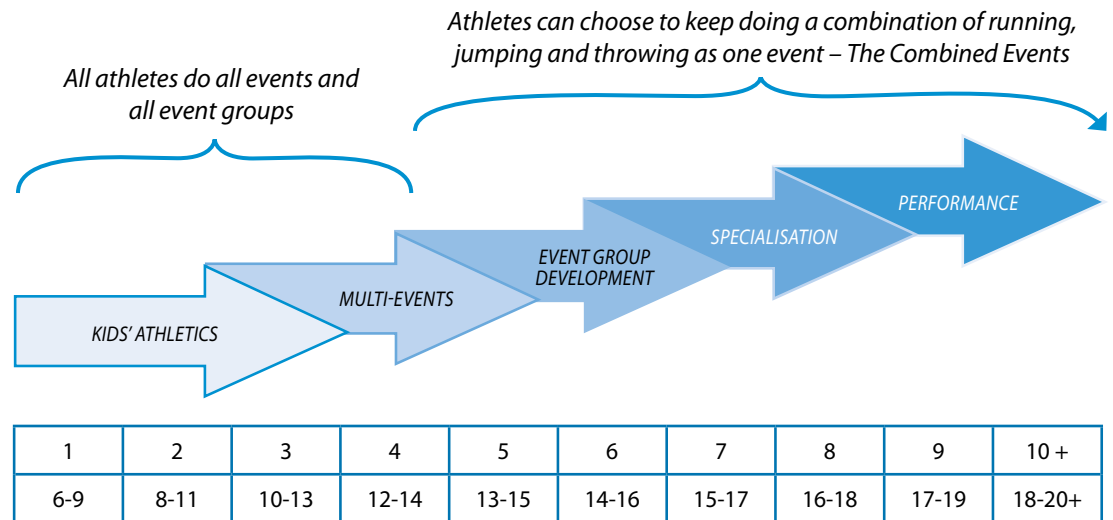

*The IAAF Athlete Development pathway and the Combined Events*

Athletes who have the highest potential for performance in the Combined Events will show excellent 'physical literacy' in the Multi-Events stage of development.

## TRAINING FOR THE COMBINED EVENTS

In the Kids' Athletics and Multi-Events stages of development, all athletes should do two or three event activities in each training session. Athletes who choose the Combined Events event group in the Event Group Development stage keep doing two to three events per session. For this reason, coaches and athletes in the Combined Events frequently use microcycles of 14 days duration. This is because microcycles of 14 days allow the athlete to train all events in each microcycle in a way which permits appropriate variety and adaptation between sessions.

### Technique Training for the Combined Events

Combined Events athletes do not need the technique of champions for each event. They do not need to be an 'elite javelin thrower', for example. But they do need an efficient and simple 'basic' technique for each event. If we continue with the Javelin example, a Combined Events athlete may not have the skills to withdraw a javelin in the approach. They may start the approach with the javelin in the withdrawn position. The better their basic technique in each event the better their final score will be. The result, however, is determined by the combined total of all events, so the emphasis for the coach and athlete must always be on a balanced technical and physical development across all events.



*"I am very pleased to welcome the publication of the latest edition of 'Run! Jump! Throw!' - the official IAAF guide to teaching athletics. I am convinced that this book, which has already served the sport well, will have a very positive impact in this new, updated and simplified, practical format."*

Lamine Diack, IAAF President

The IAAF's aim is to provide what coaches need and what new and experienced coaches around the world want – enough guidance to allow them to get on with their work and learn by doing. *Run! Jump! Throw!* does just that in a clear, user-friendly format.

This book was originally written because time and time again the coach-lecturers who were educating new coaches needed it. But, when they searched for such a book they came up empty-handed. In addition, many sports students desperately want a simple guide to the techniques of athletics that they can take out and use in schools and on the training track. As coaches gain experience they know that an easy-to-use reference is invaluable as a quick review of the basics before coaching an event which they had perhaps been away from for a while.

*Run! Jump! Throw!* helps coaches and athletes to teach and refine athletic technique by:

- An understanding of the key points for teaching and learning the event
- A technical model for their athletes to emulate
- The ability to analyse technique themselves
- A teaching progression of activities through which their athletes can learn and develop the desired technique.



International Association of Athletics Federations  
17 rue Princesse Florestine, BP 359, MC98007, Monaco